

superbee
GLOBAL DESIGN GROUP

kotra buyKOREA Partner

**VISUAL DESIGN
PHOTOGRAPHY
WEB DESIGN
MEDIA DESIGN
PRODUCT DESIGN
MARKETING**

Wanna BEE, You Can BEE

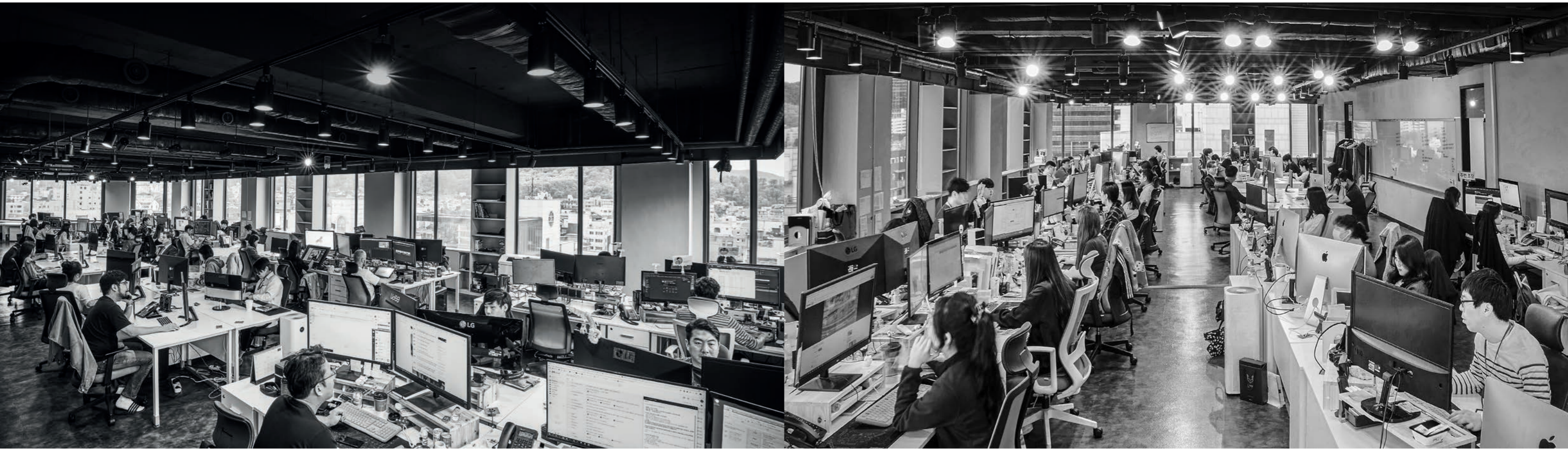

(주)수퍼비글로벌디자인그룹은 전 세계 기업의 브랜딩, 시각디자인, 제품디자인, 기구설계, 사진촬영, 홍보영상 제작, 웹사이트 제작, 구글검색엔진마케팅(SEO), 이커머스 등 기업의 브랜드 아이덴티티 정립을 위한 최고의 결과물을 제공하는 종합전문디자인 기업입니다. 올인원 디자인 솔루션부터 해외 마케팅까지 기업에 필요한 다양한 서비스를 지원하고 있습니다.

Superbee Global Design Group is an integrated design company that provides the best results for establishing brand identity of companies such as branding, visual design, product design, mechanical design, photography, filming production, web design, SEO and e-commerce. We support a variety of services necessary for companies from all-in-one design solutions to overseas marketing.

CONTENTS

VISUAL DESIGN	04
PHOTOGRAPHY	80
PRODUCT / MECHANICAL DESIGN	102
MEDIA DESIGN	122
WEB DESIGN	148
MARKETING	166

VISUAL DESIGN

- Editorial Design
- CI&BI Branding Design
- Package Design
- Advertisement & Exhibition Design
- Character Design

The visual design team pursues design outcomes that are based on strong empathy with Superbee clients. Also, our Total Communication Solution enables delivery of exclusive visual design outcomes covering Branding, Editorial, Package and Graphic design.



VISUAL DESIGN

EDITORIAL DESIGN

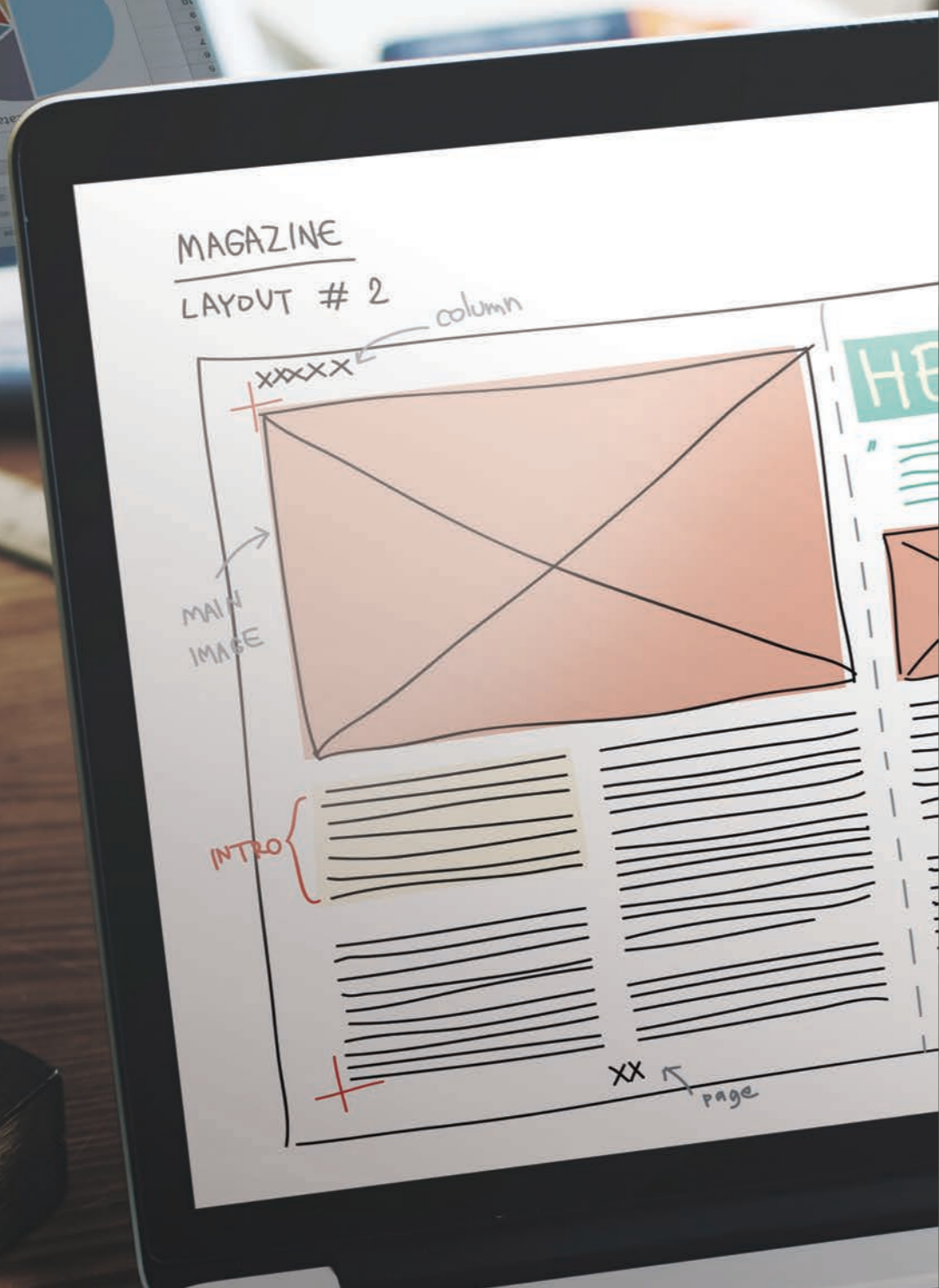

Client: Hwayo
Project: Catalogue, photography, and website

We, The PlantEat, is a plant-based alternative ingredient & protein product startup. Our mission is to solve the global malnutrition problem caused by excessive meat consumption.

The PlantEat

About The PlantEat

Company Name - The PlantEat Inc.
Founded Date - 24th Mar 2017
Founder - Jacob Yang
Business Services
 B2B | Selling core material and semi-finished products (e.g. soybean powder) and out-licensing tech and brand.
 B2C | Selling products under our plant-based food brand, Eat's Better.

The PlantEat's R&D Capabilities

Raw Material - We develop our plant-based protein through our unique processing of soybeans exclusively designed for the creation for alternative food use.

New Ingredient Discovery System - Based on our diverse food compounds database collection and food matching algorithm, we develop and create our core semi-finished ingredients for diverse use our plant-based products.

Product - We develop and sell plant-based alternative foods through in-house knowledge workforce team who have extensive experiences in developing plant-based alternative material, ingredient, and products.

The PlantEat Inc.
 Based in Cyong-gi, Korea
 Tel: +82 (0)31.337.7777

EAT PLANTS FOR THE PLANET

"Sustainability", "Environmental Friendliness", "Happiness", and "Harmony" to provide a better life to our consumers through better food."

Eat's Better Mayo - Adding the health benefits of Yakkong!

Specifications: 240g x 100x1 Box
 Product Size: 40mm x 70mm
 Shelf Life: 6 months - COLD STORAGE
 *Only 30 Days Refrigerated Storage will be available
 *Net Wt: 100 grams (3.52oz) per
 Retail Price: \$4.9 (USD)

Why Eat's Better Mayo?

- 100% Plant-based
- Healthy Beans
- No Egg
- 0% Cholesterol

Eat's Better Mayo - Adding the health benefits of Yakkong!

Ingredients: Soybean oil, Water, Fermented wheat, Soybean Soy Protein Powder, Black Bean Powder, Unsulfured Sugar, Rice Sprout, Soy Protein Isolate, Refined Salt, Arabic Gum, Modified Corn Starch, Emulsifier (Water, Polyglycerol stearate of fatty acids (G75, Ethanol), Stabiliser (Xanthan Gum (E415)), Emulsifier (Soybean Esters of Fatty Acids (E471), Lemon Juice Concentrate, Disodium Rosemary Thiophyllate (E309), Anti-oxidant (D-Tocopherol (E307)) Natural Flavouring

ALLERGY: Soybean

Nutrition Facts	
1/3 Serving Per Container	
Serving Size	
Amount per serving	% Daily Value*
Calories	90
% Daily Value*	
Total Fat 1g	2%
Saturated Fat 0.5g	1%
Trans Fat 0g	0%
Cholesterol 0mg	0%
Sodium 0mg	0%
Total Carbohydrate 1g	2%
Dietary Fiber 0g	0%
Total Sugars 0g	0%
Protein 0g	0%
Alcohol 0g	0%
Iron 0mg	0%
Calcium 0mg	0%
Iron 0mg	0%
Protein 0g	0%

*% Daily Value is based on a diet of 100% plant-based ingredients. This is not a nutrition label for a daily diet. 100% plant-based is a goal to be achieved through a healthy diet.

Client: The PlantEat
Project: Catalogue

Y-Biologics
 #1, 26, Seoncheon-ro, Seoncheon-gu, Gangwon-do, Korea
 T: +82 (0)33 959 7140 | F: +82 (0)33 959 7141 | E: info@ybiologics.com
 www.ybiologics.com

Exploring Antibodies. Creating Novel Biologics.

"A Global Leading Company in Antibody Therapeutics"

Y-Biologics is a biotech company focused on the discovery and development of novel therapeutics in various antibody modalities including bispecific antibodies and antibody drug conjugates.

Discovering Innovative Antibody Therapeutics

Offering solutions to current unmet medical needs in immune oncology, Y-Biologics is a biotech company focused on the antibody discovery with emphasis on the field of immune oncology and autoimmune disease.

Table of Contents	
Quick Facts	03
Milestones / BD Strategy / Collaboration Partners	03
Ymax-B-ABL (Human Antibody Library)	04
Platform & Pipeline	05
ALIX (Antibody-Like Cell Engager)	05
Platform & Pipeline	06
Developmental Candidates	06
COVID-19	07

Quick Facts

Founded in 2017, Y-Biologics is a biotech company specialized in discovering and developing innovative antibody-based therapeutics for the treatment of cancer. We have secured the pipeline by utilizing two proprietary technologies, a fully human antibody cDNA library and unique T cell-specific antibody format.

Platform Technology

Ymax-B-ABL: Proprietary fully human naive cDNA library
 ALIX: Antibody-Like Cell Engager: Novel format of T cell-specific antibody

Pipeline

Pipeline with various modalities including monoclonal / bispecific antibodies and ADC in the field of immunology and autoimmune disease

Funding

Secured 35 million USD in Nov. 2018

Milestones

- 2020. 07 Collaboration agreement with Pfizer Fabry for development of novel monoclonal antibody for multiple tumor tissue treatment targets.
- 2016. 06 AMT and Y-Biologic merged to "Y-Biologics Inc."
- 2020. 07 Licensing and commercial antibody in field of immune oncology targets to LG bioscience.
- 2016. 05 Collaboration agreement with SK Bioscience Health Care for development of three most specific antibodies utilizing Ymax-B-ABL.
- 2012. 11 Contract with Sanofi for the discovery of the first BCL-2 target antibody.
- 2017. 04 Collaboration agreement with Biologics to development of a bispecific iCp antibody.
- 2007. 12 Founded as AMT Therapeutics with proprietary antibody discovery platform.

Business Development Strategy

Y-Biologics appreciates the power of ideas and research capabilities of external organizations. We have a flexible business model and powerful platform technologies to generate novel antibody therapeutics for potential collaboration.

- Y-Biologics as platform technology that licensing
- Research collaboration using our platform technologies and facilities
- Co-development with companies of experience and reputation in the clinical development of monoclonal or bispecific antibody
- Establish a joint venture for sharing platform risk in oncology and there for a specific target to be discovered

Collaboration Partners

Client: Y-BIOLOGICS
Project: Catalogue



Client: Jeil Spiral
Project: Catalogue, banners and photography



Client: Dongnam
Project: Catalogue



Client: System Base
Project: Catalogue





Client: OwnU
Project: Catalogue, photography, and video



Client: Kitten Planet
Project: Leaflet and photography

Client: Public Kitchen
Project: Leaflet and video



Client: BODYLOGIC
Project: Catalogue and video



Client: Kwangjuyo
Project: Catalogue



Client: SAMBO CERAMICS
Project: Catalogue and photography





Client: SmallMachines
Project: Catalogue design



Client: S-Modul
Project: Catalogue design



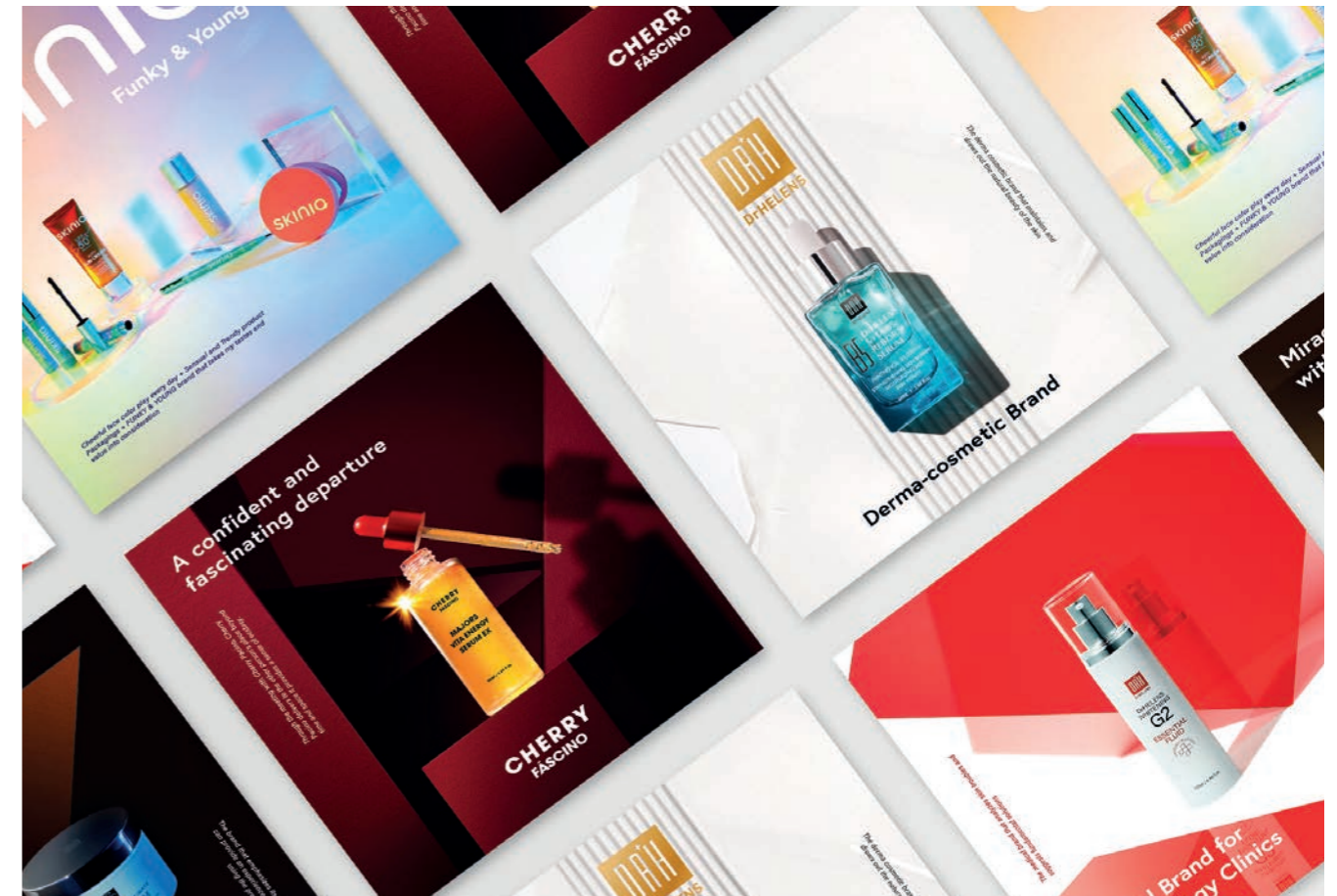

Client: BASIA | Project: Brand identity design



VISUAL DESIGN

CI & BI BRANDING

	CMYK 35: 30: 0: 0 WEB/HEX b4b3da RGB 180: 180: 220 #Pantone 270C
	CMYK 0: 50: 10: 0 WEB/HEX fca3bb RGB 250: 160: 185 #Pantone 189C
	CMYK 65: 45: 40: 30 WEB/HEX 5b6670 RGB 90: 100: 110 #Pantone 431C

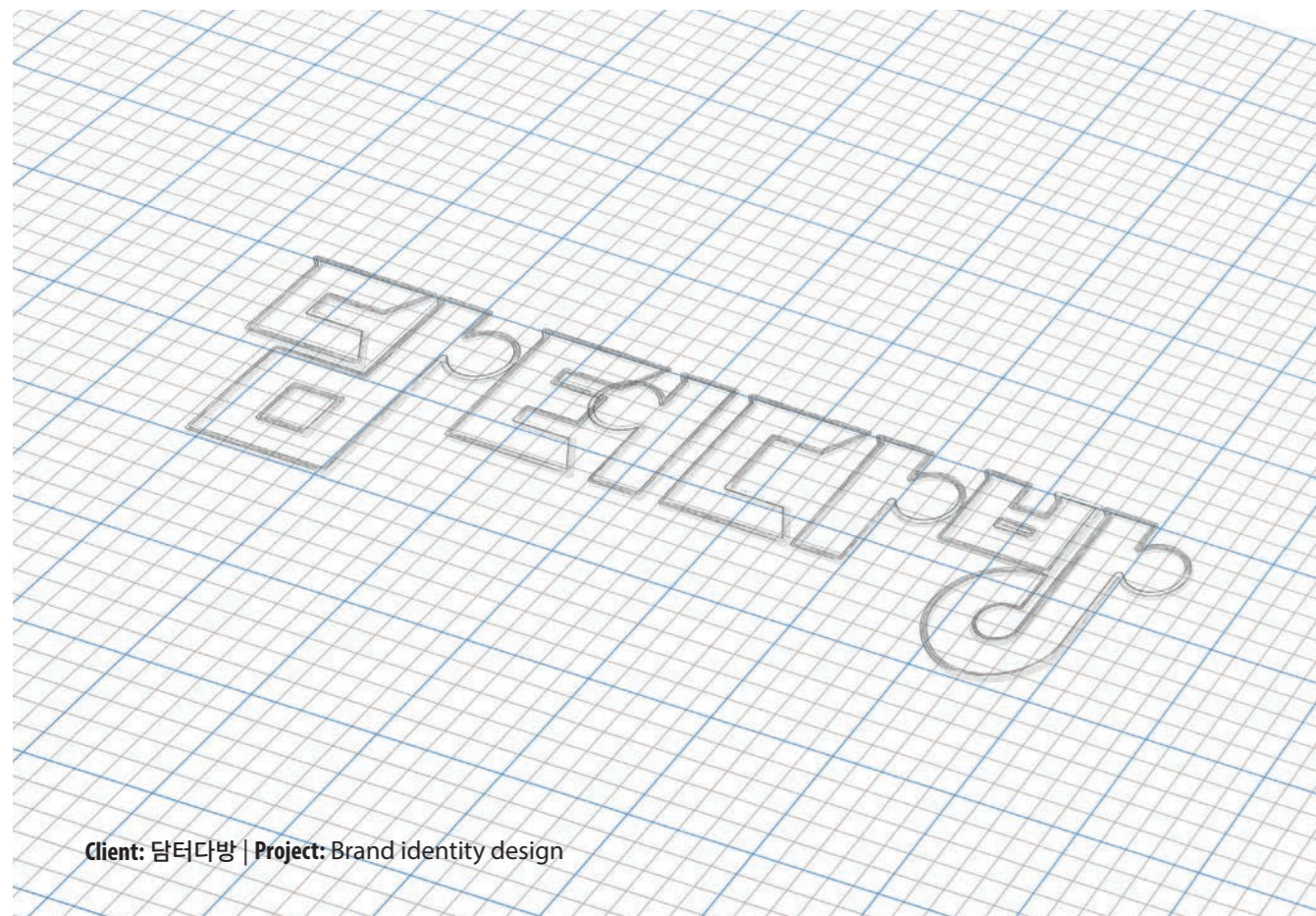

Client: 담터다방 | Project: Brand identity design



Client: Footy | Project: Brand identity design



Client: 카피어랜드
Project: Corporate identity design

[copierland]



Client: 디건강 하나로
Project: Brand identity design



D건강 하나로



Client: Vinafarm
Project: Corporate identity design



Client: 자반고래밥 (Jaban)
Project: Brand identity design



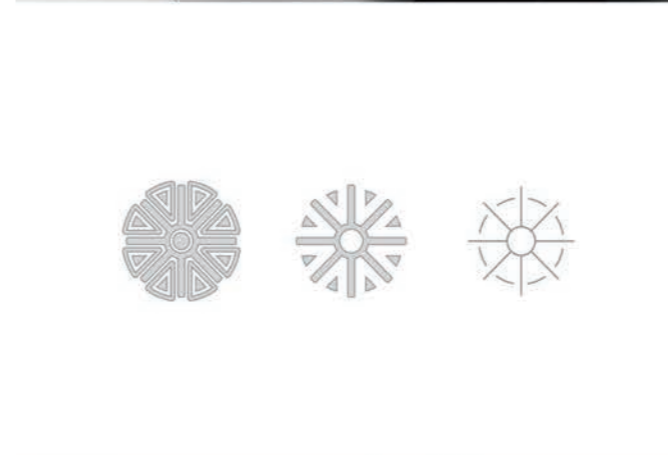

Client: HONEST
Project: Corporate identity design



Client: ROBOROBO
Project: Corporate identity design

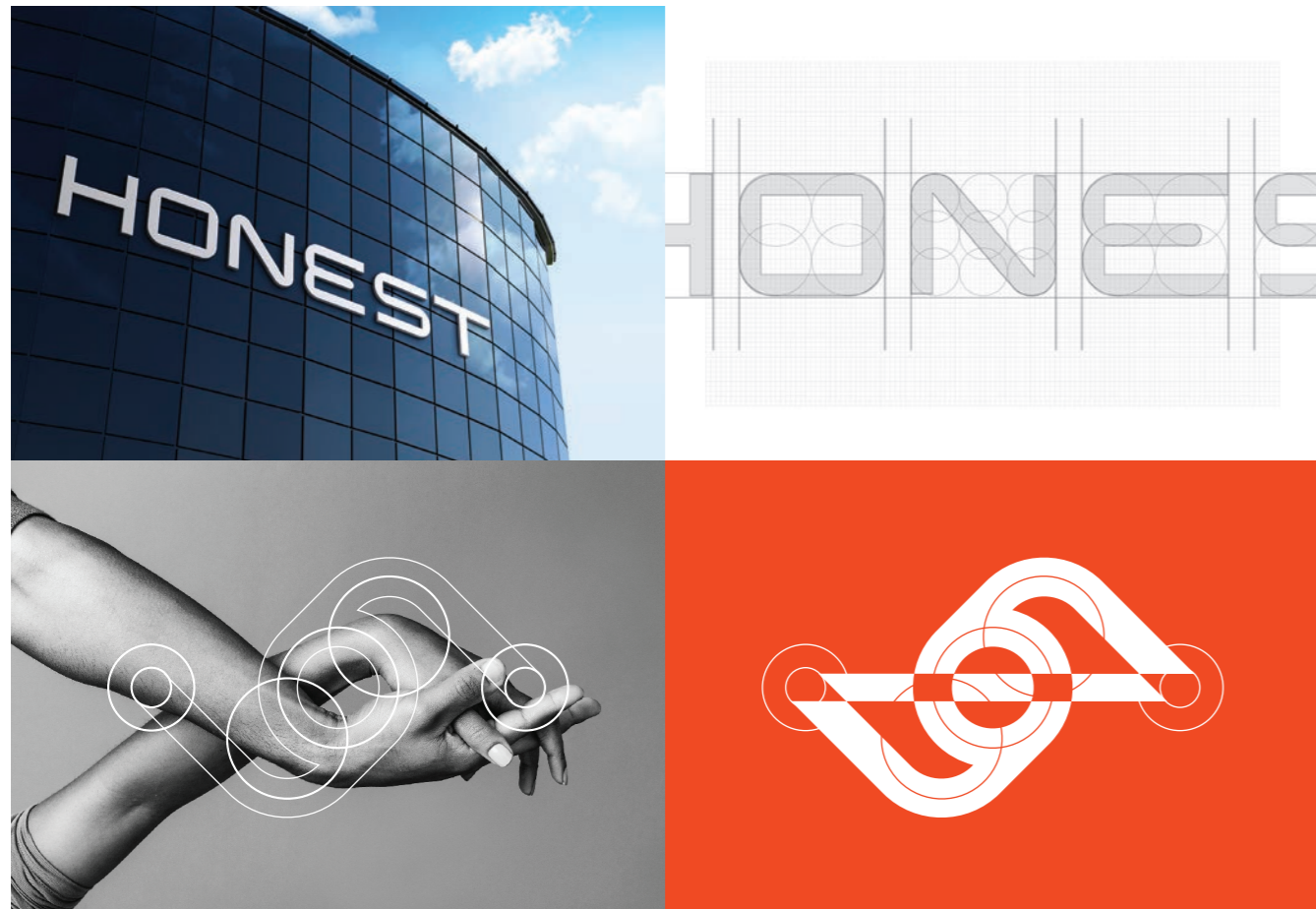

Client: Dongwootec | Project: Corporate identity design



Design Concept

Color System



PANTONE 7548C
C0 M30 Y100 K0
R250 G190 B0

C0 M0 Y00 K100
R35 G24 B21

Negative Color System



Client: Leemetal | Project: Corporate identity design



Design Concept

Color System



PANTONE 3115C
C70 M0 Y25 K0
R32 G190 B198

PANTONE 2163C
C60 M40 Y30 K0
R116 G139 B158

PANTONE 2377C
C95 M80 Y40 K40
R26 G48 B80

Negative Color System



Client: Haegang | Project: Corporate identity design



Design Concept

Color System

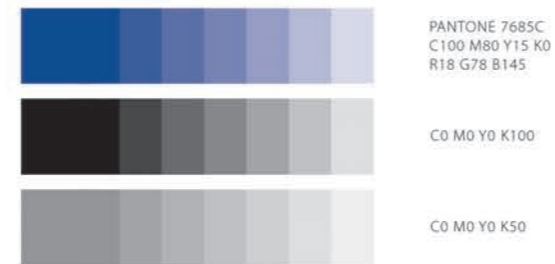

Negative Color System



Client: Stemko | Project: Corporate identity design



Design Concept

Color System



Negative Color System



Client: Handol Pumps | Project: Corporate identity design

Client: Hyupjin Precision CO.,LTD.(DexBro) | Project: Brand identity design



Design Concept



Color System

	PANTONE 485 C C0 M93 Y82 K0 R231 G87 B87
	PANTONE 425 C C0 M0 Y0 K80 R89 G87 B87
	PANTONE Blue Cool Gray 5C C0 M0 Y0 K40 R181 G181 B182

Negative Color System

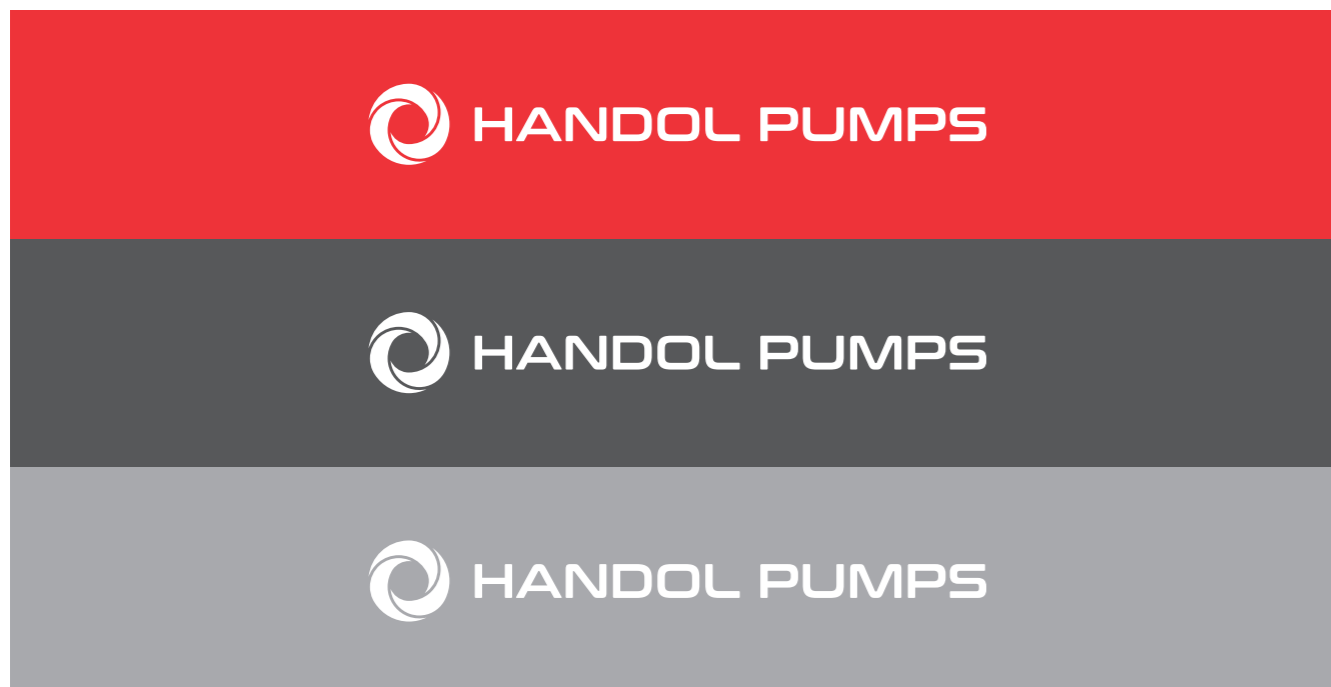

Main Color



PANTONE 1-8C
C0 M0 Y100 K0
R112 G111 B111
#706F6F

Sub Color



PANTONE 169-8C
C43 M36 Y41 K0
R163 G157 B148
#a39d94



PANTONE 33-12C
C40 M55 Y61 K28
R135 G100 B81
#876451



PANTONE BLACKC
C0 M0 Y0 K100
R29 G29 B27
#1d1d1b



Client: Texkor(Somsajang) | Project: Brand identity deesign



Color System

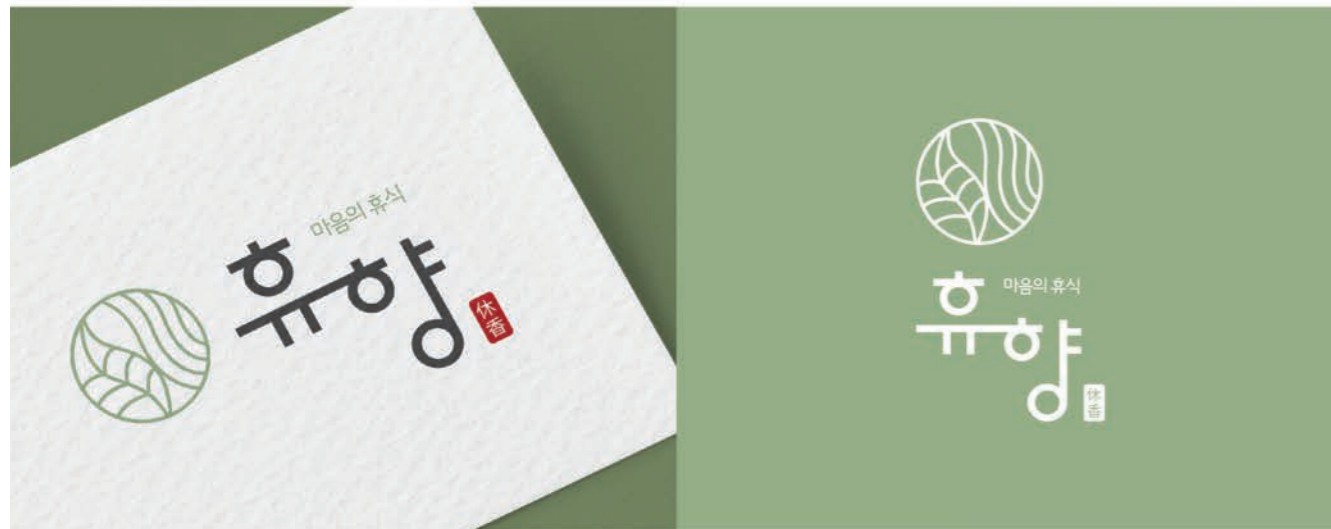

Color System

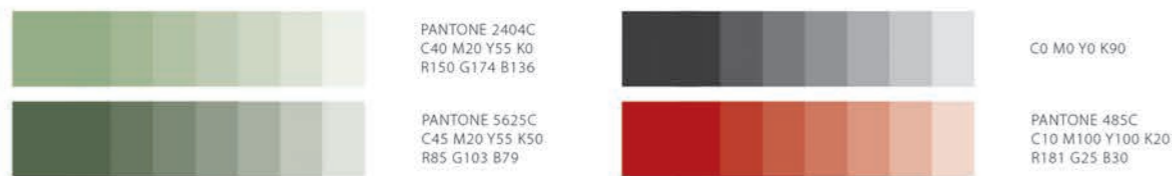

Client: Kuper G | Project: Kuper G Brand identity design



Color System

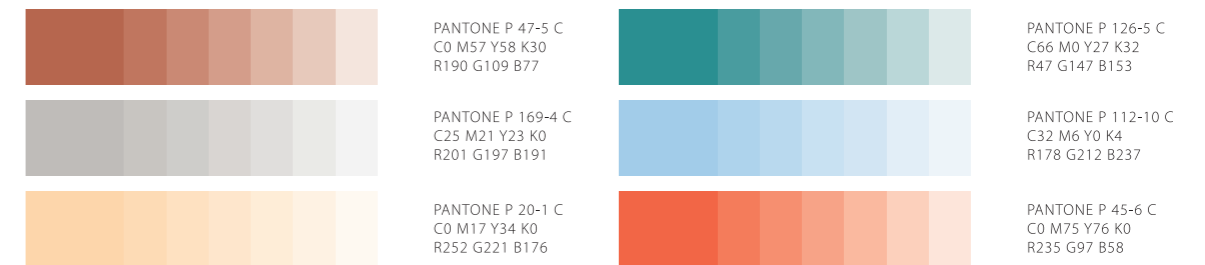

Negative Color System



VISUAL DESIGN

PACKAGE DESIGN



Client: ESTER
Project: Cleansing foam package design





Client: Lucky Planet
Project: Pouch package design



Client: Kitchen Flower
Project: Titanium casting frypan package design



Client: Daepungsusan
Project: Meal kit package design



Client: Zipiny
Project: Charcoal package design



Client: Q-MAC
Project: Stainless steel grill package design



Client: SOBOKO
Project: Sauce package design



Client: Q-MAC
Project: Barbecue grid package design



Client: Taekyung Food
Project: Laver package design





Client: Kooksoondang
Project: Bokbunja wine package design



Client: Bookyung Food
Project: Meat steak package design



Client: 제일타카 (Jitool)
Project: Packaging design



Client: 서해씨앤씨 (YouEarth)
Project: Packaging design



VISUAL DESIGN

ADVERTISEMENT & EXHIBITION DESIGN





아이디어

제27회 중소벤처기업 지원 아이디어 공모전

2019.05.31 (금) 18:00까지

공모대상 전 국민 (공통 참가인 경우 팀단위 (3명 이내) 가능)

공모일정 참가신청 ~ 2019년 5월 31일 (금) 18:00까지
 수상작 발표 ~ 2019년 6월 17일 (수) (일상편의가능)
 시상식 개최 ~ 2019년 7월 중 (일정변경가능)

참여방법 홈페이지 (www.kosmecontest.com)를 통해 접수하여 작성방법 및 기타 유의사항 등은 홈페이지를 참조

지원분야 중소벤처기업지원분야 / 규제개선분야 중 택 1
 *자세한 사항은 왼쪽 하단 QR코드 또는 홈페이지 (www.kosmecontest.com) 참조

포 상 총 20편, 상금 총 2천 백만원

구분	분야	복합편수	복합규모
대상	통합	1편	상장 및 상금 500만원
최우수상	중기지원	2편	상장 및 상금 200만원
	규제개선	1편	상장 및 상금 100만원
우수상	중기지원	4편	상장 및 상금 100만원
	규제개선	2편	상장 및 상금 50만원
장려상	중기지원	6편	상장 및 상금 80만원
	규제개선	4편	상장 및 상금 30만원

우 리 수상 후 2년 이내 중진급 및 해임/드루제 인사지원 시 우대 (기타)
 규제개선 분야 중 혁신성장 8대 선도산업* 주제관련 용역서 기입부여
 *혁신성장 8대 선도산업: 조양철 지원회, 스마트 공장, 스마트 밀, 핀테크, 드론, 에너지저장, 스마트 시티, 자율 주행차

문의처 중소벤처기업진흥공단 혁신전략팀 (055-751-9297, 9289)

지원분야 확인



Client: KOSME
Project: Poster design and brochure



Client: Kooksoondang
Project: Poster, banner, photography, and catalogue

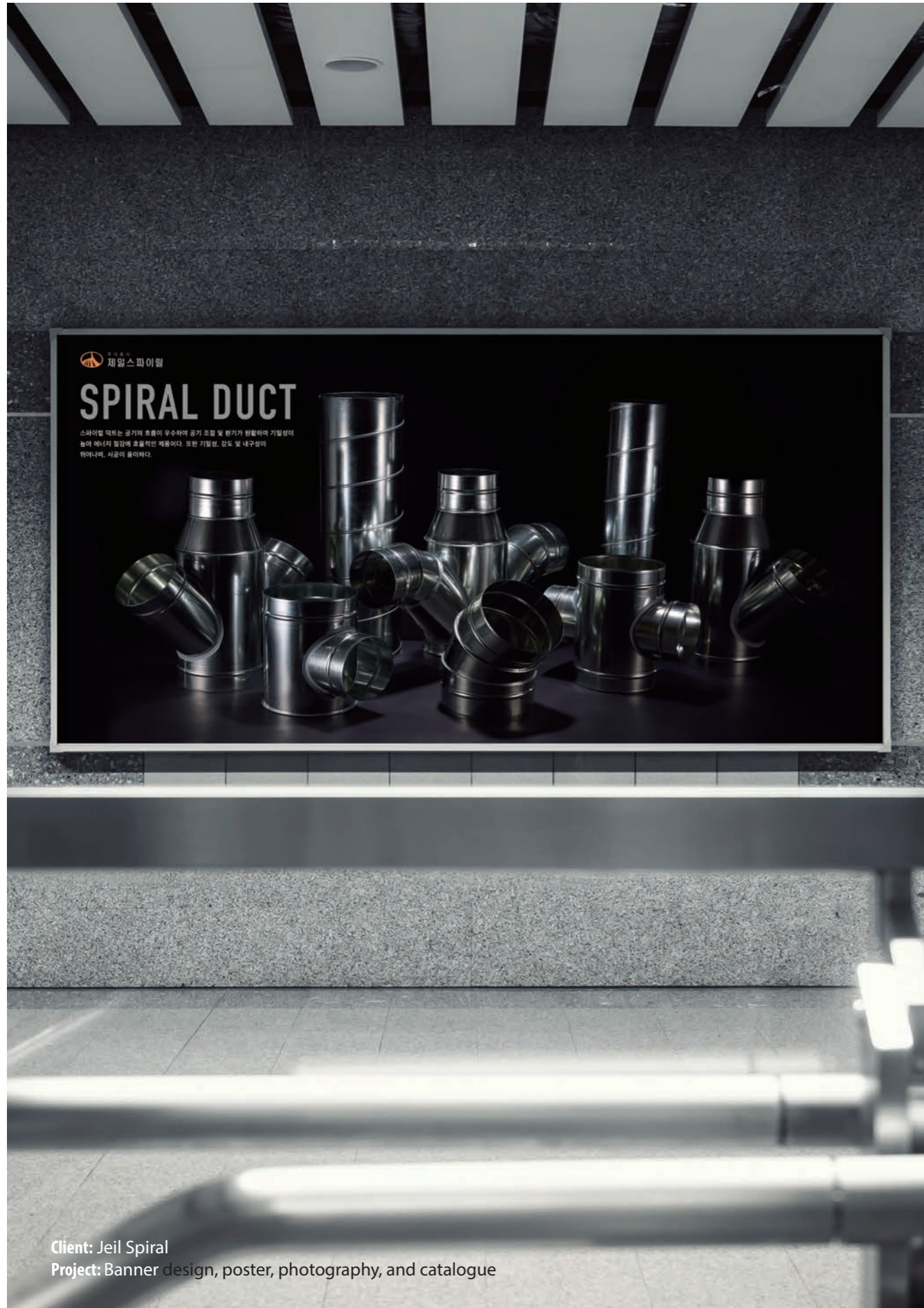

Client: Jeil Spiral
Project: Banner design, poster, photography, and catalogue





Client: Derma J
Project: Banner design



Client: Kotra
Project: Newspaper advertisement



Client: Ease
Project: Banner design, logo, and catalogue



Client: Kotra
Project: Newspaper advertisement



Client:
MDK Dental

Project:
Poster design
and catalogue



Client: JMW Korea
Project: Poster design



Client: BE&BI Tech
Project: Banner design and catalogue



Client: Borsec
Project: Banner design



Gobiz KOREA

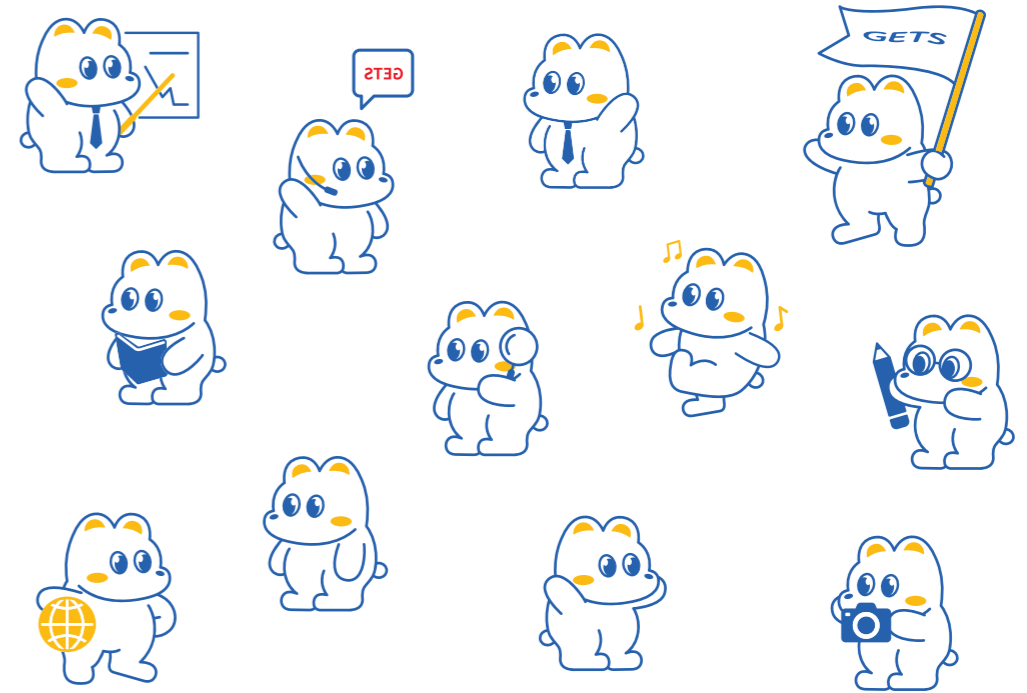

Client: GOBIZKOREA
Project: Character Design



VISUAL DESIGN

CHARACTER DESIGN

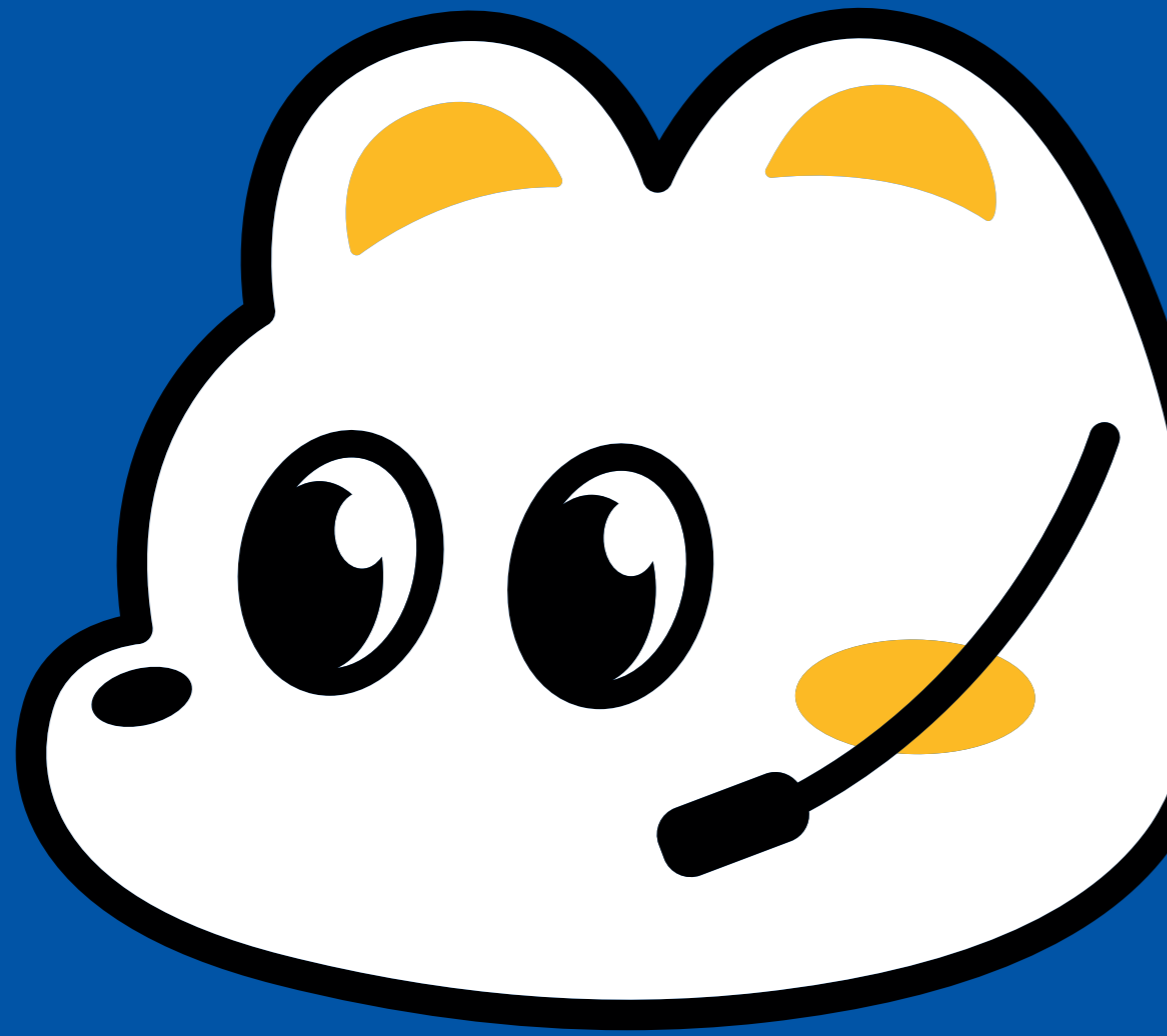



Client: 중소벤처기업진흥공단 (KOSME)
 Project: Character/ Illustration/ Catalogue/ SNS contents design

mini poki

CUTE KITCHENS IDEAS

미니포키는 딱 계란 크기의 작은 토끼예요.
 나를 표현하는 것을 중요하게 생각하는 포키는
 큰 귀가 돋보이는 두건을 색상별로 여러개 갖고 있어요.
 예쁘게 차려입고 이야기 꺼리가 많은 친구들과 함께
 꽃파이를 만드는 것이 취미랍니다.

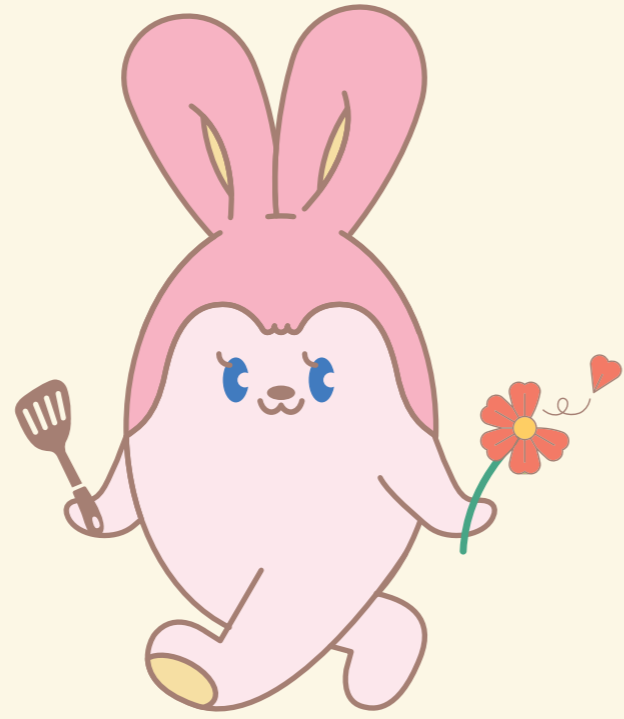

Client: Mini poki
 Project: Character design

Mr. Good News

YOU ARE DOING GREAT

오늘 아침 브런치로 만든 핫케이크이 너무 잘 구워졌지 뭐야?
 이런, 오늘 좋은 일이 있을 것만 같아.
 미스터 굿 뉴스랑 함께한 브런치를 누구에게 자랑할까 고민 중이야~
 모자 아니야, 나한테 꼭 붙어 있으려는 Ms.Butter 라구.
 풀밭 아니야, 너가 좋아하는 휘핑크림 그거 맞아.

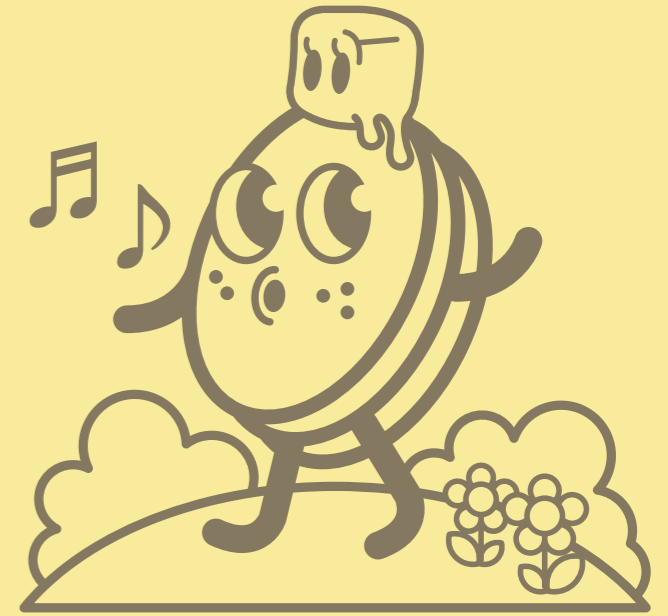

Client: Mr. Good News
 Project: Character design



Client: ZOO LIFE
Project: Character Design

Client: SUPER PEOPLE
Project: Character BI Design



Even minor actions can have a major impact
when we all work together.



**SUPER
PEOPLE**

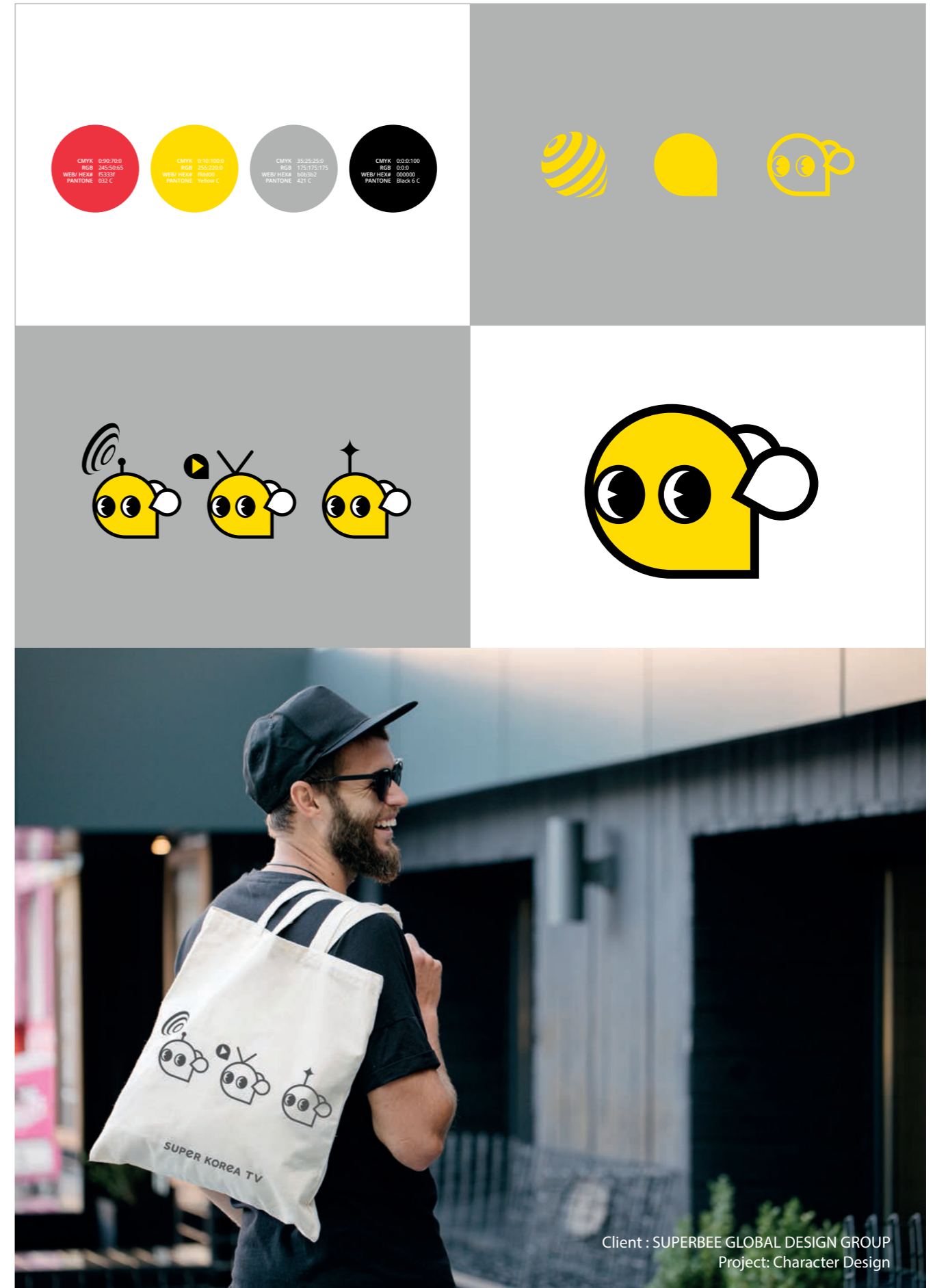

Client : SUPERBEE GLOBAL DESIGN GROUP
Project: Character Design

PHOTO- GRAPHY

- Model Image
- Interior Image
- Food Image
- Product Image

The photography team provides distinctive photos taken with comprehensive shooting strategies optimised for business industries and the needs of various brands. Completed photos can be used for extensive use in every form of branding and marketing.





PHOTOGRAPHY

MODEL IMAGE



Client: Popcorn & KiKi



Client: Popcorn & KiKi





Client: eosika





PHOTOGRAPHY

INTERIOR IMAGE



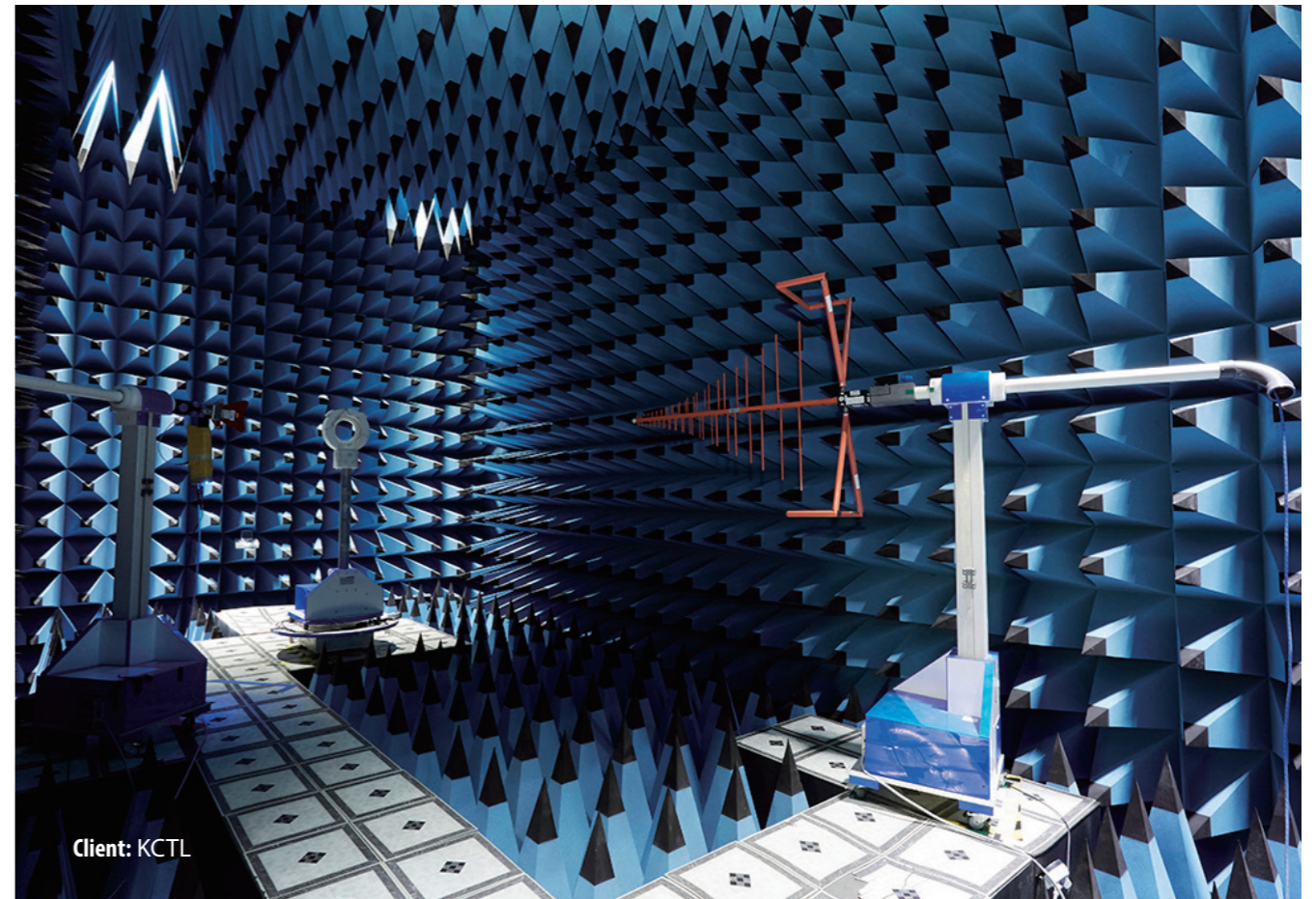
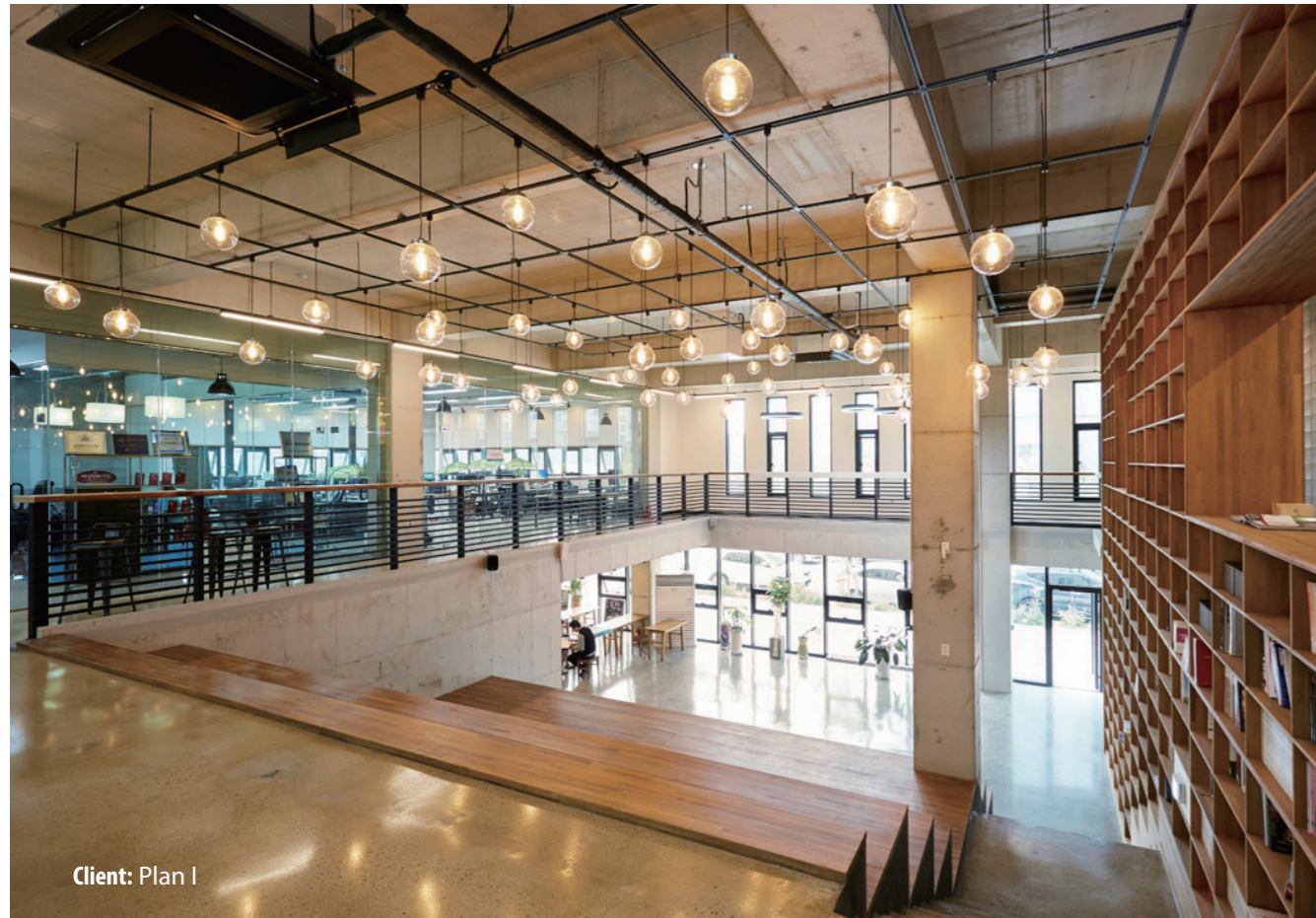

PHOTOGRAPHY

FOOD IMAGE



Client: OLHGOK



PRODUCT IMAGE

PPHOTOGRAPHY



Client: Coseed Biopharm





Client: W DRESSROOM





PRODUCT DESIGN

- Product design
- Mechanical design

Based on logical and detailed analysis, the product team manages and produces product design, internal product mechanics and production follow-up, which establishes the fundamental bases for product market entry.





Client: jw Bio Science
Project: Hybrid Incubator

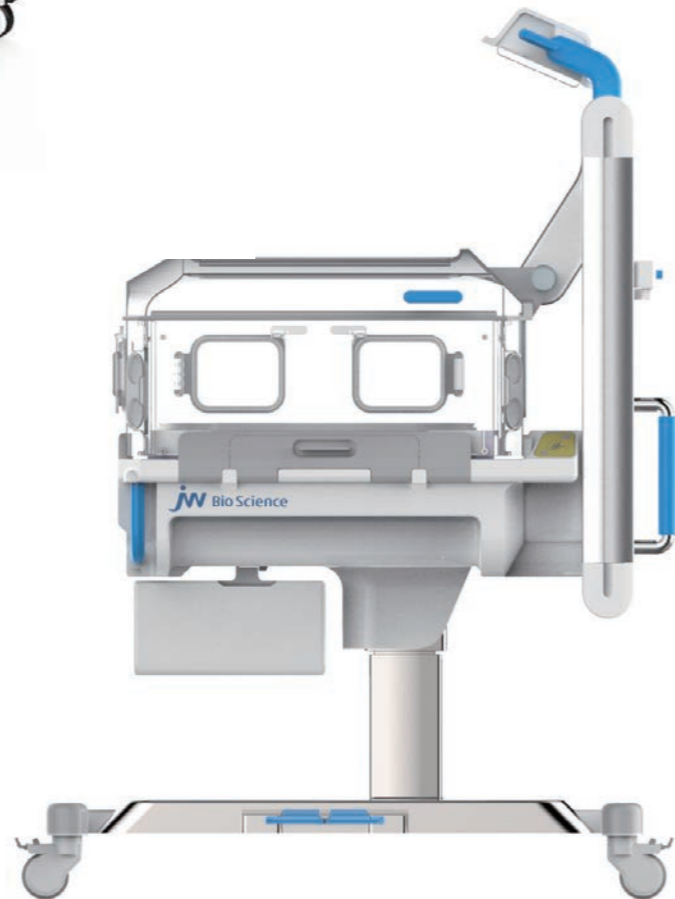

Client: MovingKey
Project: MetaTwin AI Studio



Client: TECSSEN
Project: Fingerprint recognition access security device



Client: DOS INTERNATIONAL
Project: LED MASK Device



Client: TECSSEN
Project: Fingerprint recognition access security device

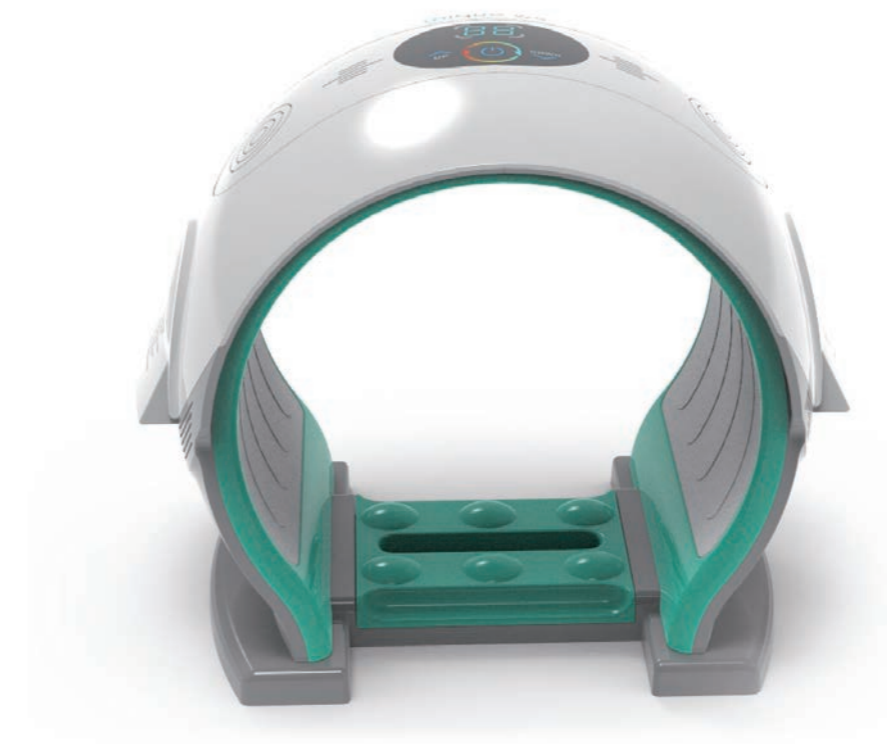



Client: PLEDO
Project: Educational robot design



Client: KS Standard
Project: F-500 Pretreatment device



Client: PLEDO
Project: Educational robot design



Client: ACI Chemical
Project: Vertical compressed waste disposal



Client: GST Engineering
Project: Entrance security gate



Client: GST Engineering
Project: Entrance security gate



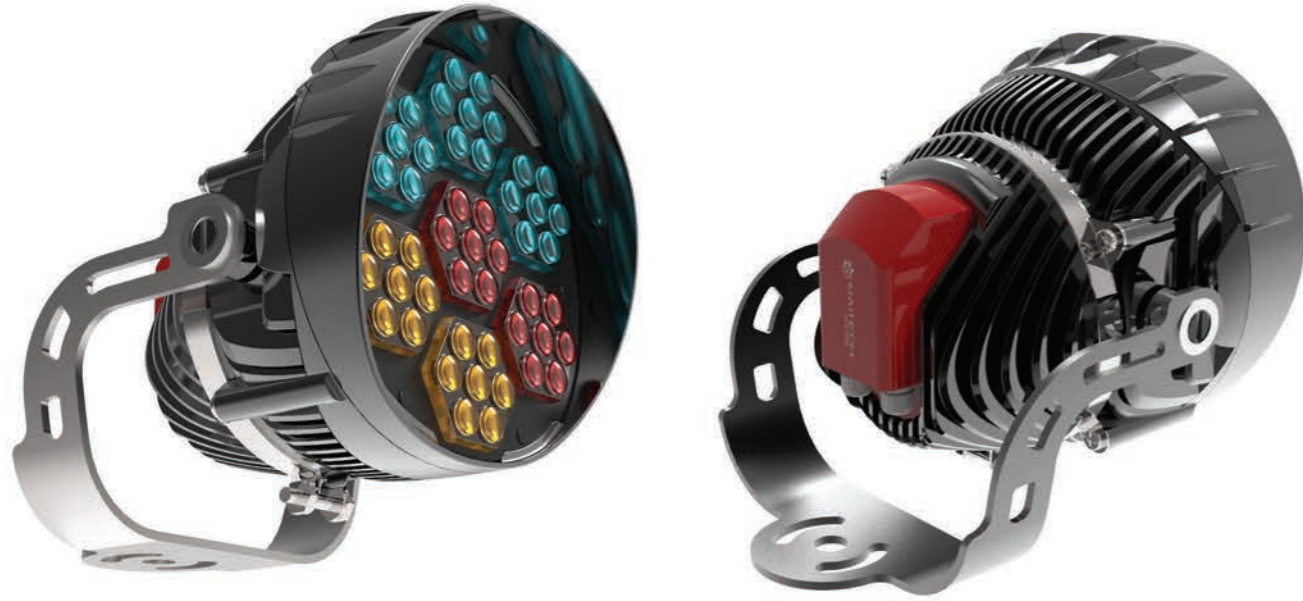

Client: MAITECH SYSTEM
Project: Sport lighting device 1



Client: KS Standard
Project: F-500 Pretreatment device



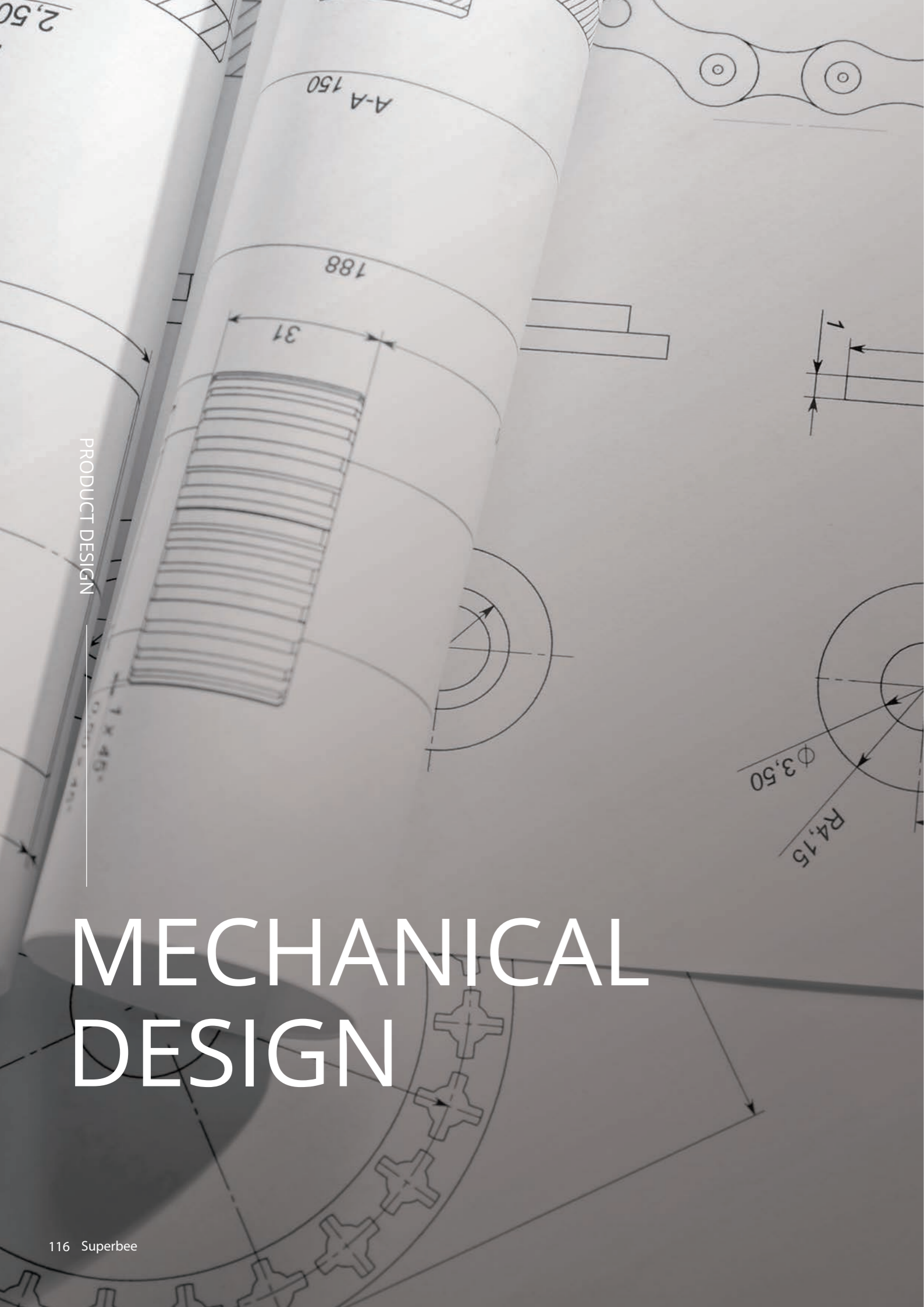

MECHANICAL DESIGN

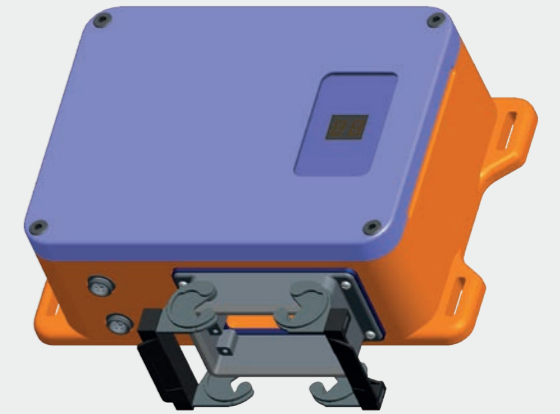
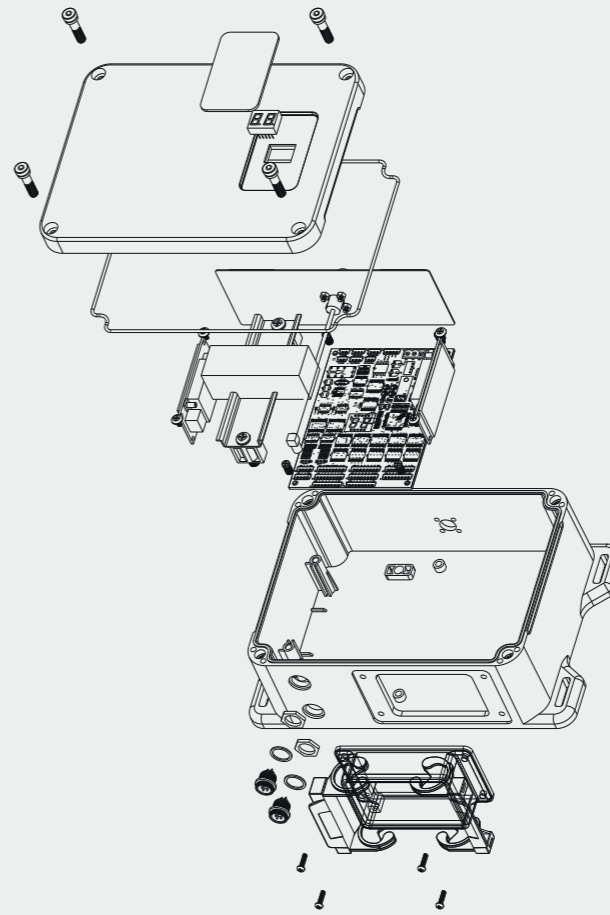

Client: Sehwan eTec
Project: Industrial remote control receiver

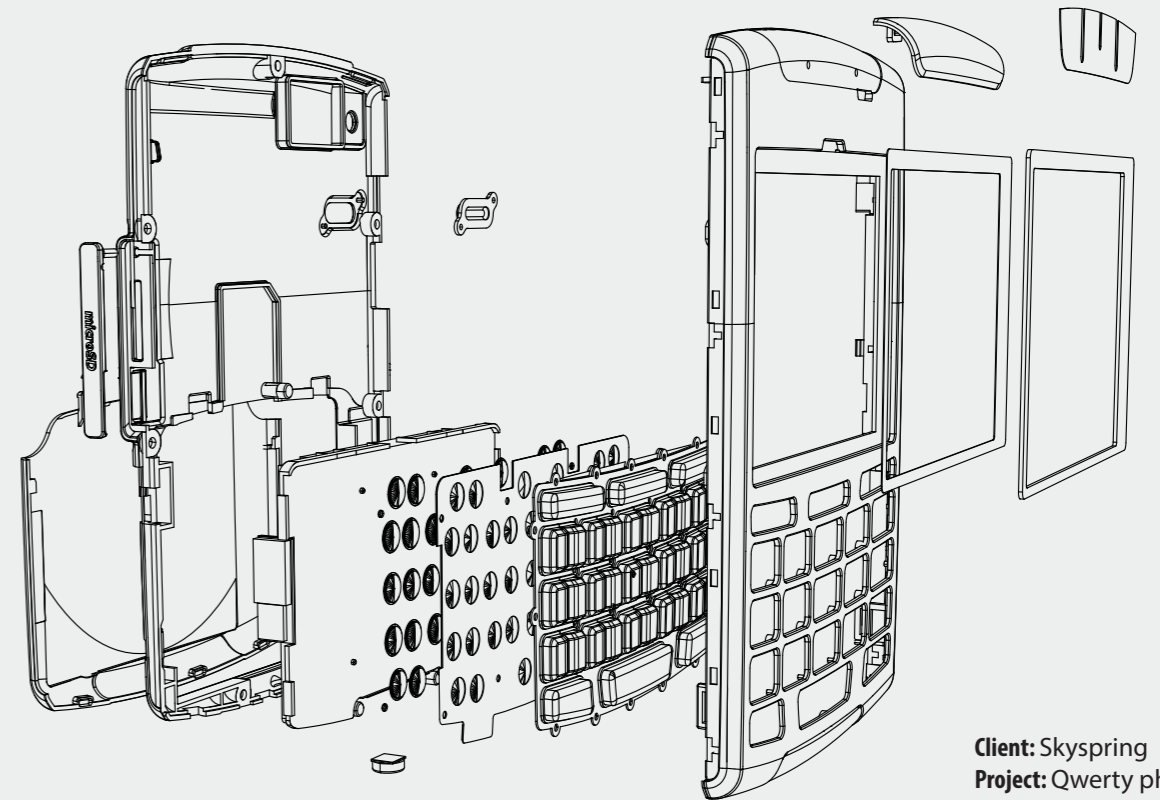

Client: Skyspring
Project: Qwerty phone

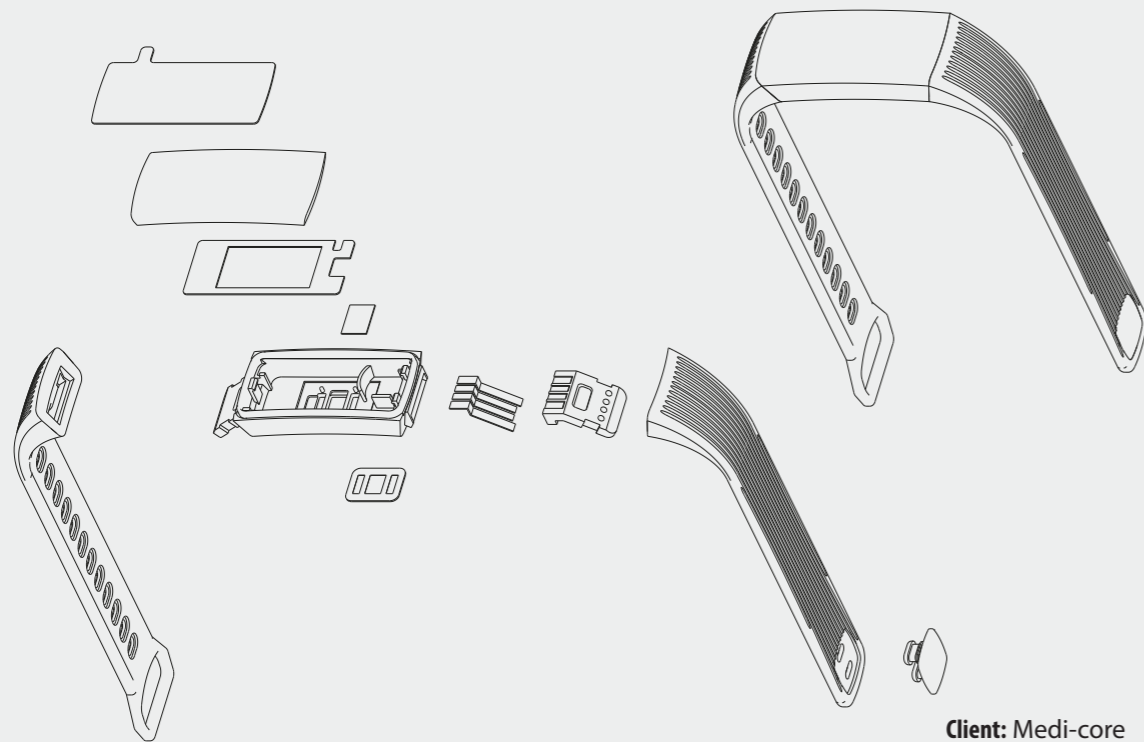
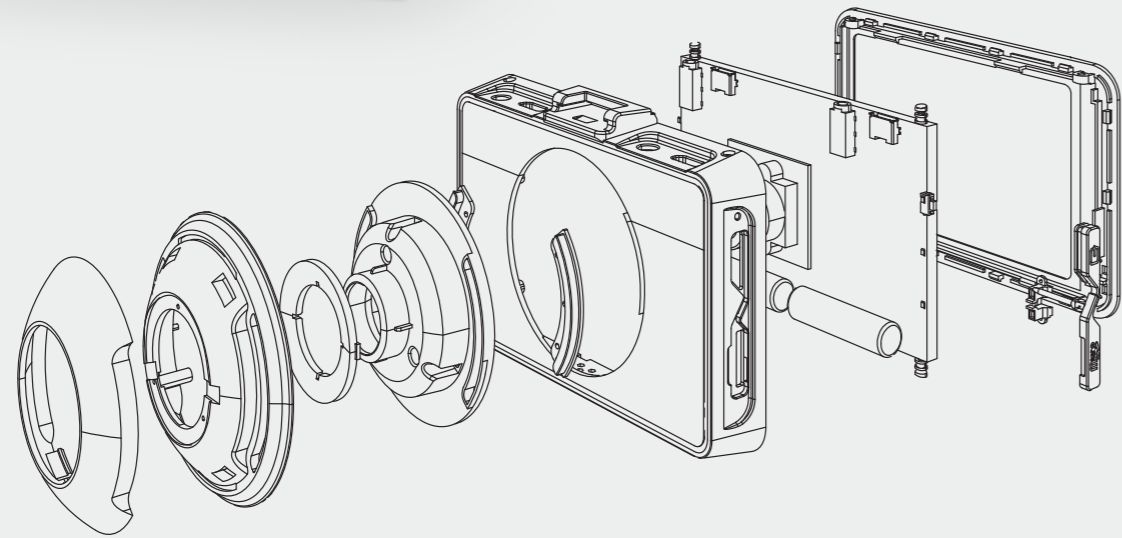

Client: Medi-core
Project: Wearable device

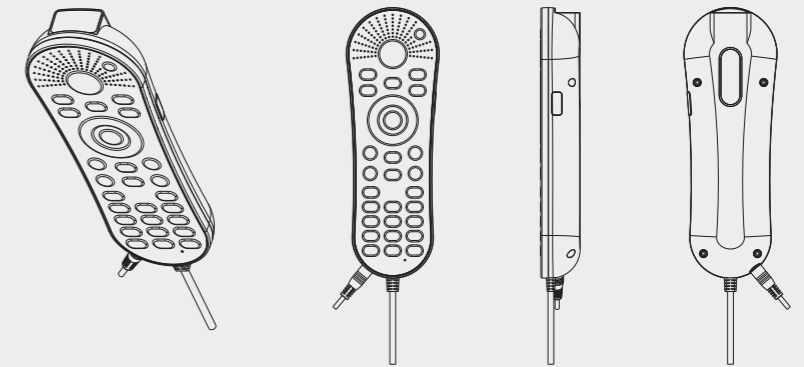
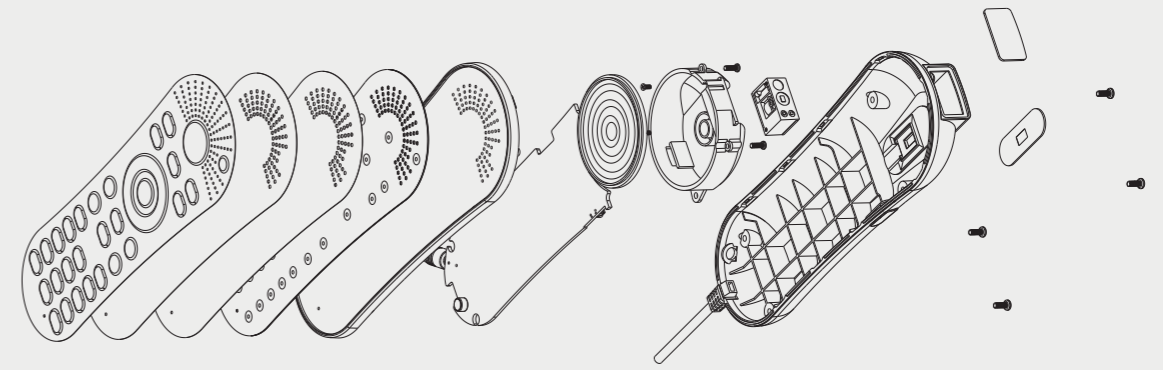

Client: ITI Technology
Project: Remote controller



Client: Finevu T50
Project: Car black box

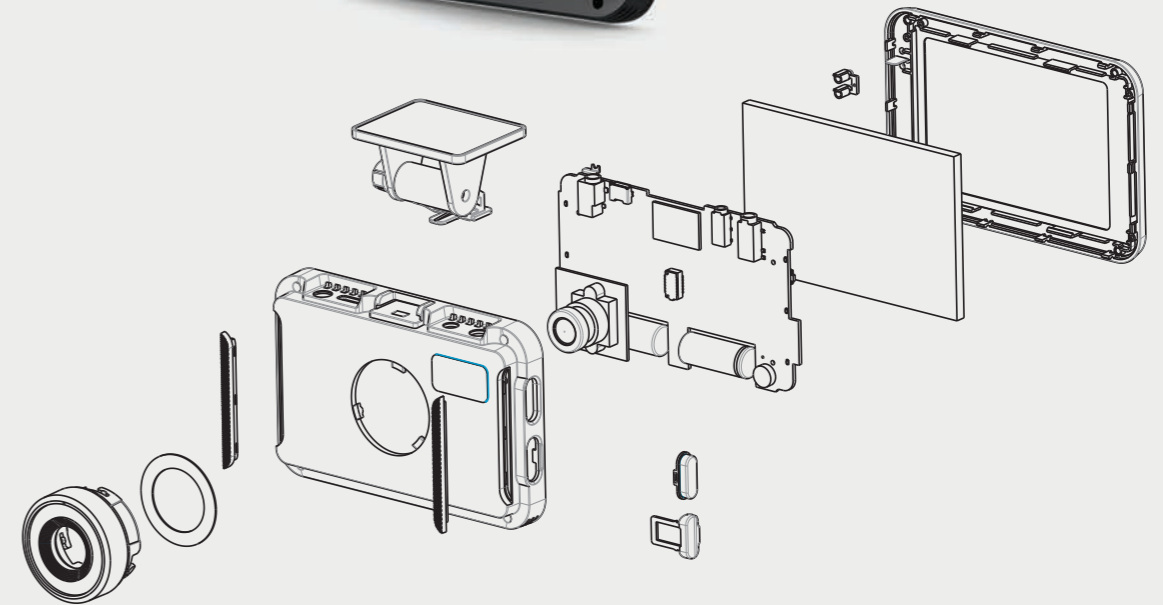

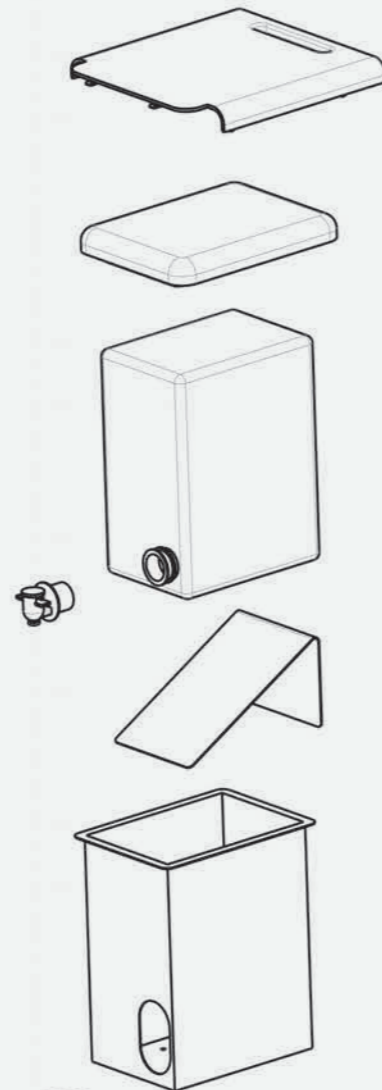

Client: Hoin
Project: Coffee dispenser



Client: FINEVU
Project: T30 Car black box

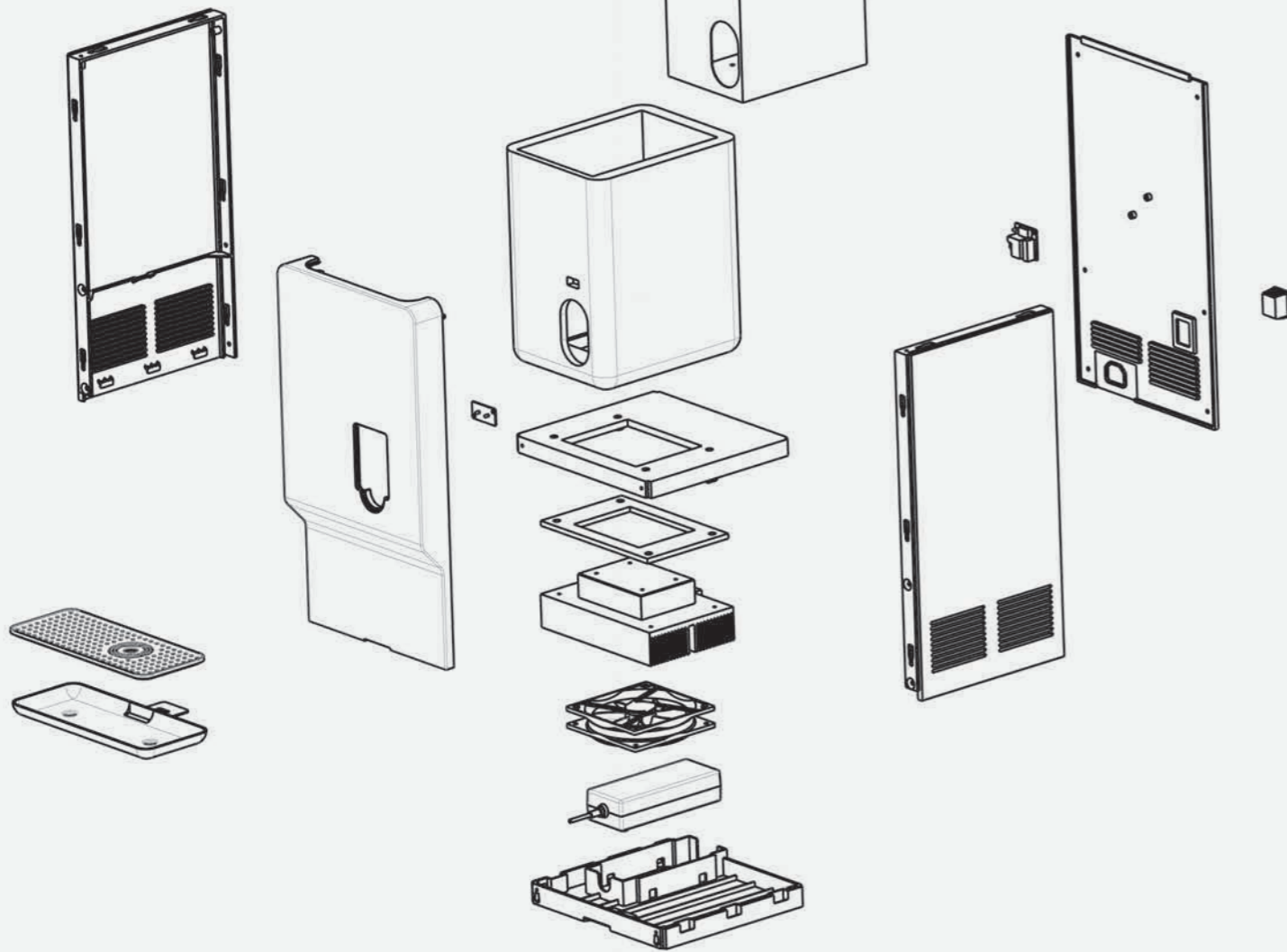

Client: FINEVU
Project: T20R Car black box

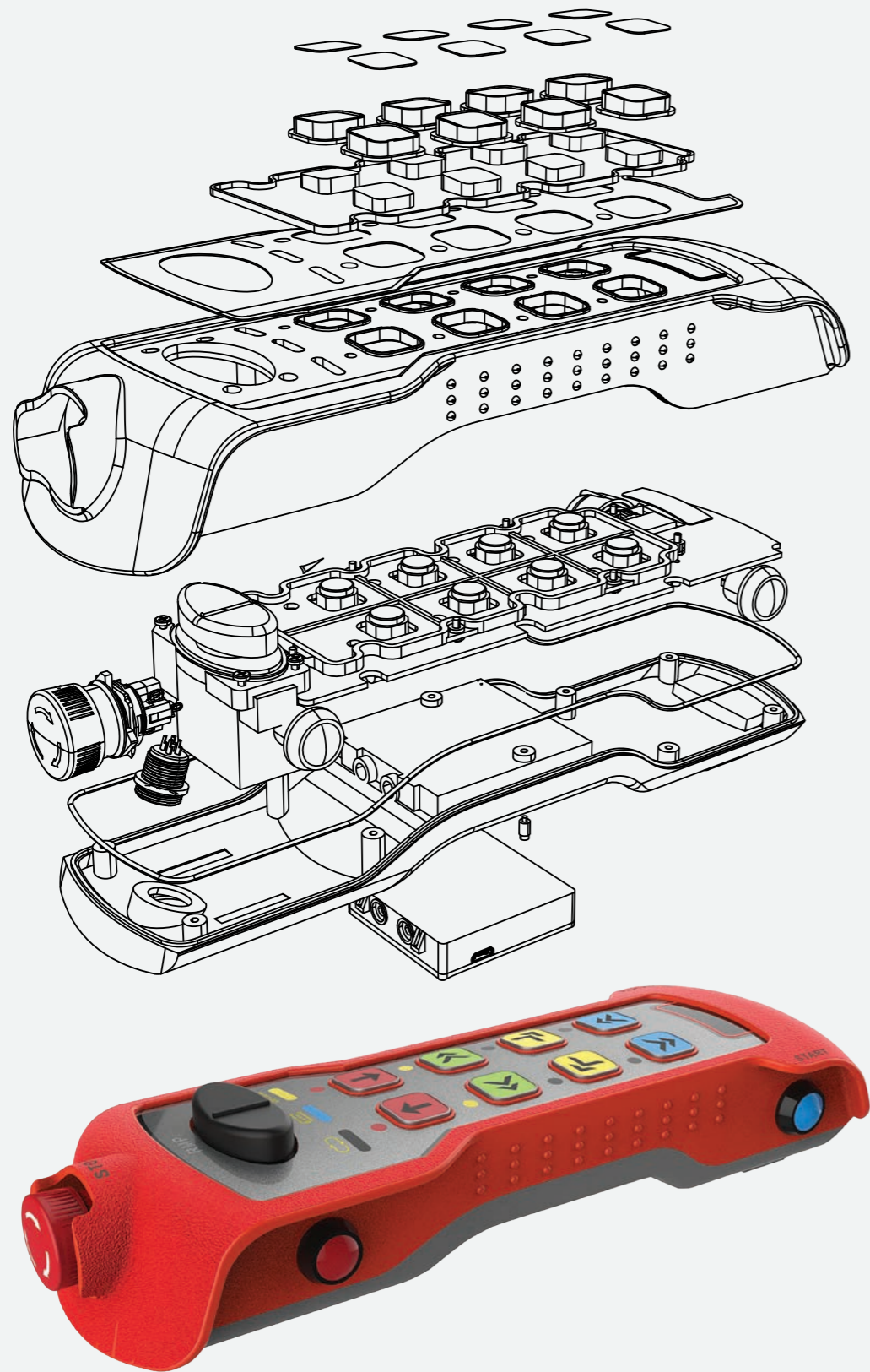

Client: Sehwan eTec
Project: Industrial Remote control receiver

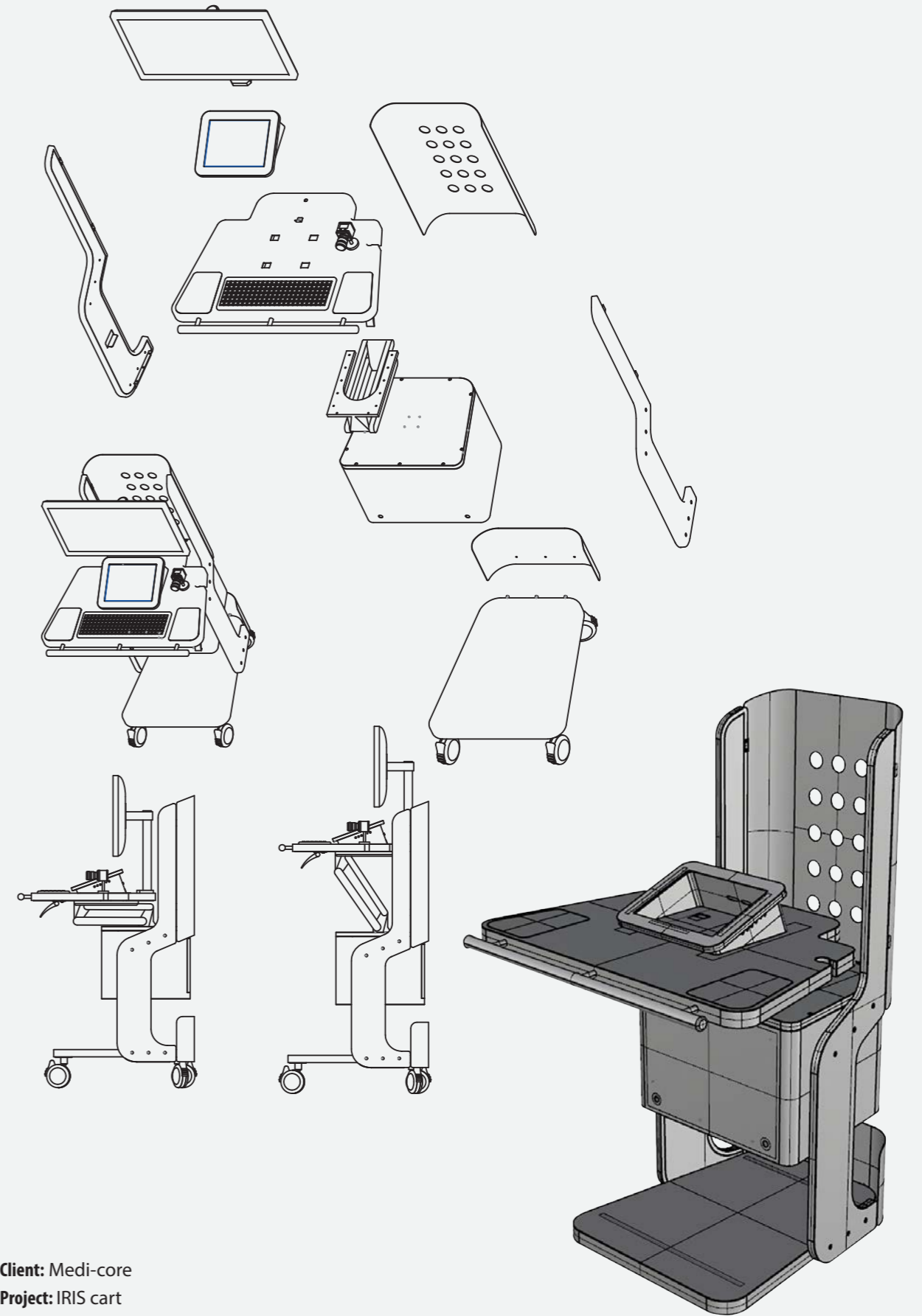

Client: Medi-core
Project: IRIS cart

MEDIA DESIGN

- Brand films
- Commercial films
- Corporate promotion video
- 2D/3D Motion graphics

The media team creates videos for defining brand identity. Equipped with in house production systems and high level shooting techniques, the team provides brand films, commercial production and 2D/3D motion design in new, creative ways.





Client: GVG
Media Type: Brand film



Client: Saint Luxure
Media Type: Brand film



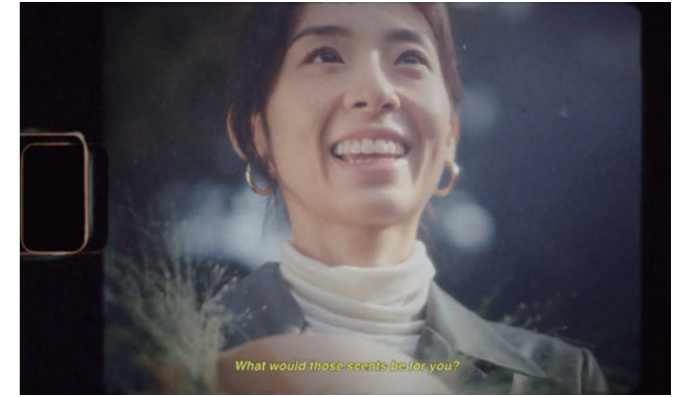

Client: PETIT[N]
Media Type: Commercial film



Client: W.DRESSROOM
Media Type: Brand film



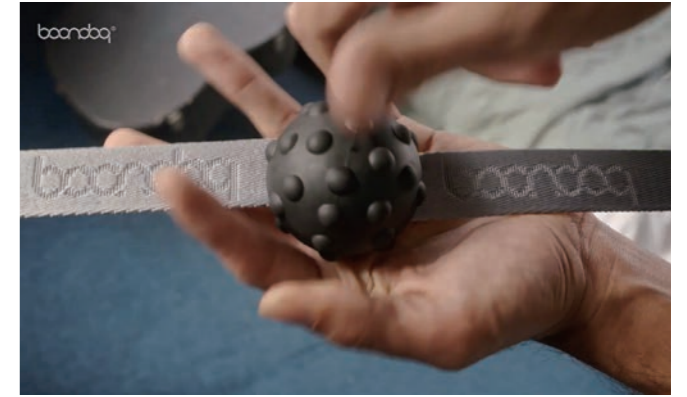

Client: Tosco
Media Type: Commercial film



Client: BOONDOG
Media Type: Brand film





Client: NK hair&skin care
Media Type: Brand film



Client: JELLY MALLOW
Media Type: Brand film





Client: COPIERLAND
Media Type: Brand film



Client: 하루이야기
Media Type: Commercial film



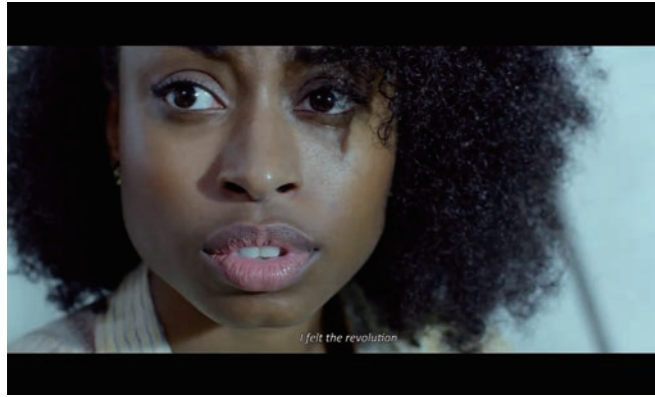
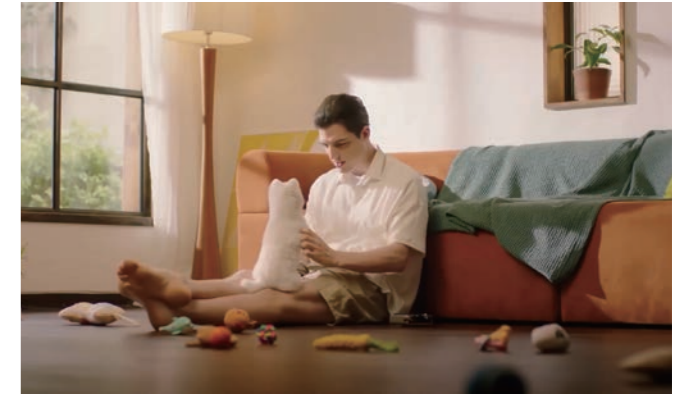
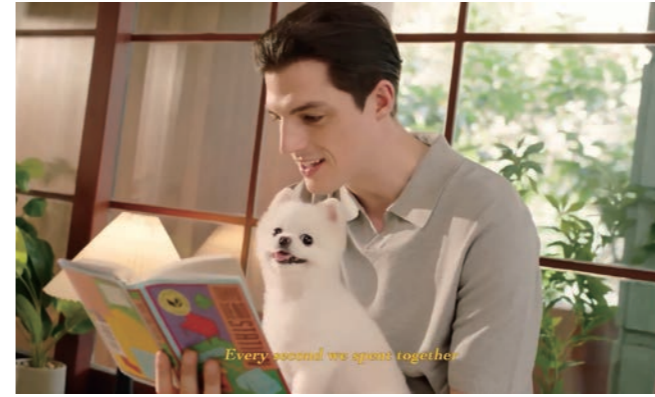

Client: AUTOELEX
Media Type: Brand film



Client: AUTOELEX
Media Type: Brand film





Client: E&S TECH
Media Type: Corporate promotion video



Client: VIVOZON
Media Type: Corporate promotion video



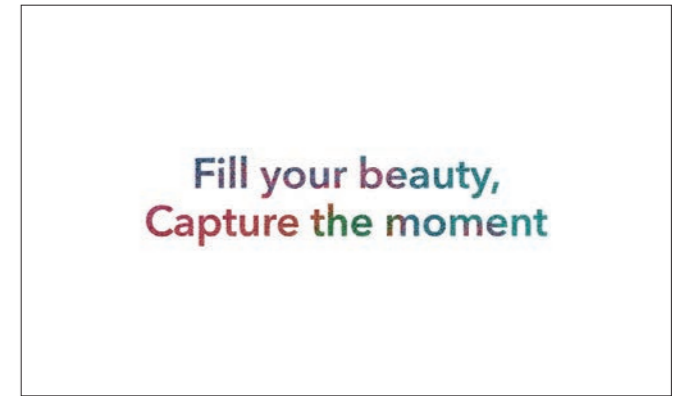
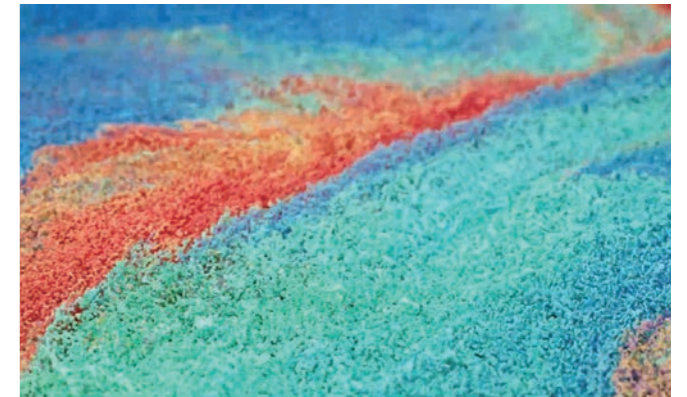
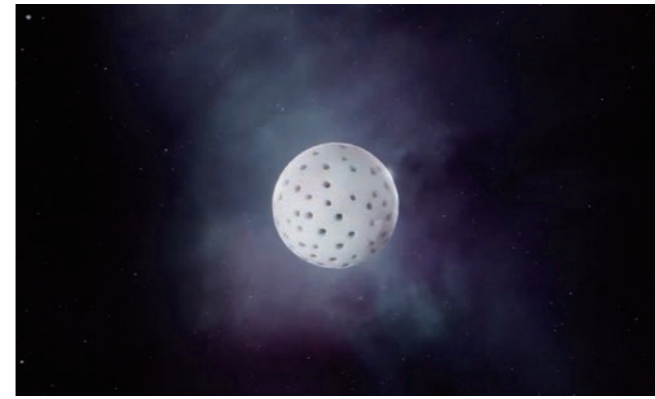

Client: XAVIS
 Media Type: Product promotion video



Client: Samyang Holdings
 Media Type: 3D Motion graphics





Client: Dermafirm
Media Type: 3D Motion graphics



Client: MARPLE
Media Type: 3D Motion graphics



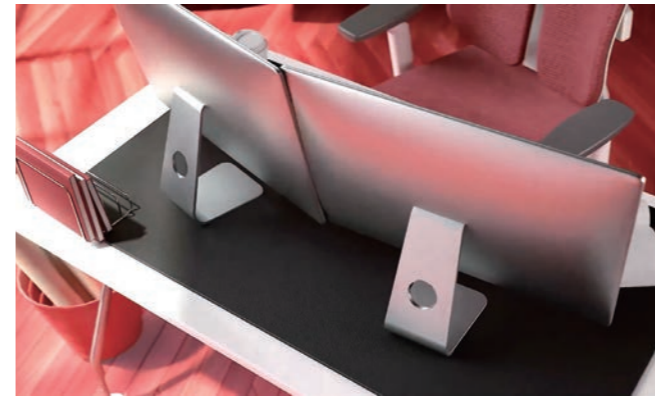

Client: Chungwoo C&T / ROBA
Media Type: 3D Motion graphics



Client: Duoback
Media Type: 3D Motion graphics



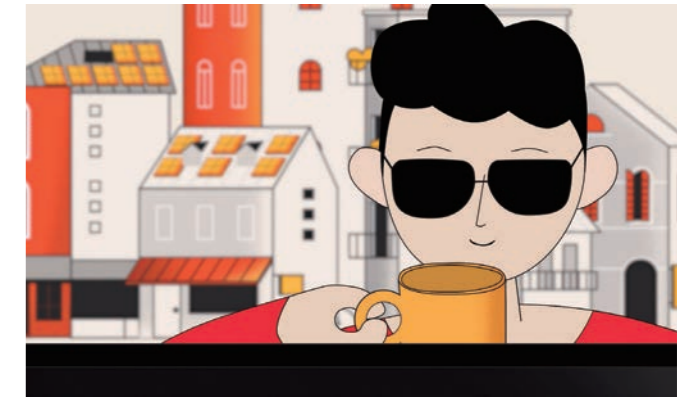
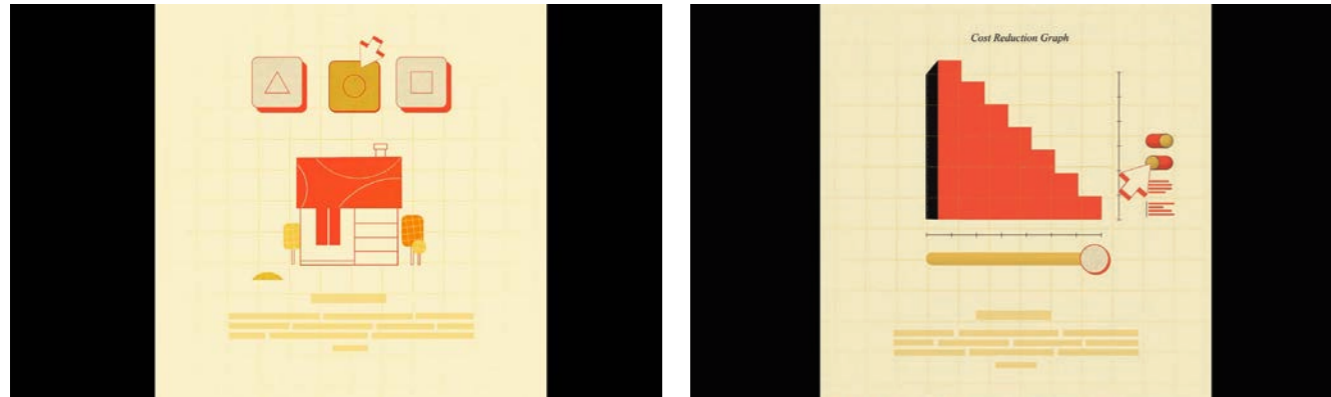
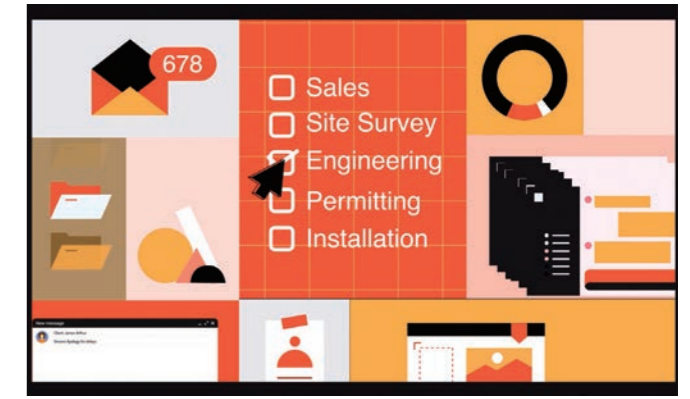

Client: ENERGY PLANNER
Media Type: 2D Motion Graphics



Client: ENERGY PLANNER
Media Type: 2D Motion Graphics



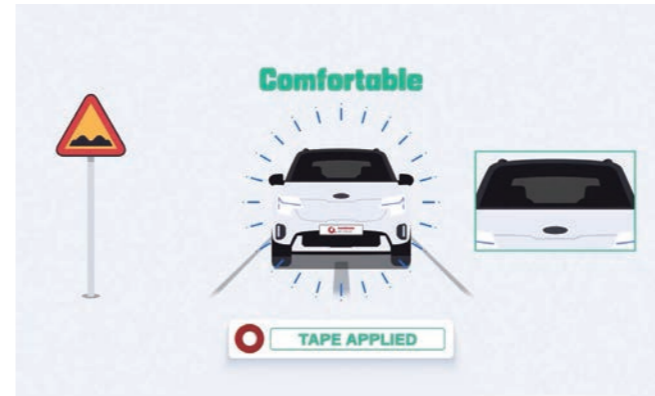
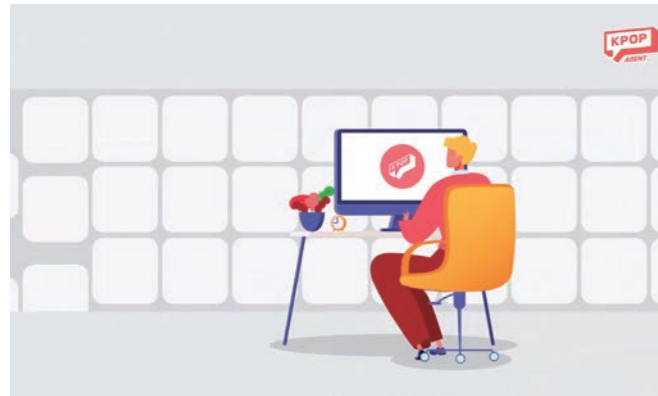
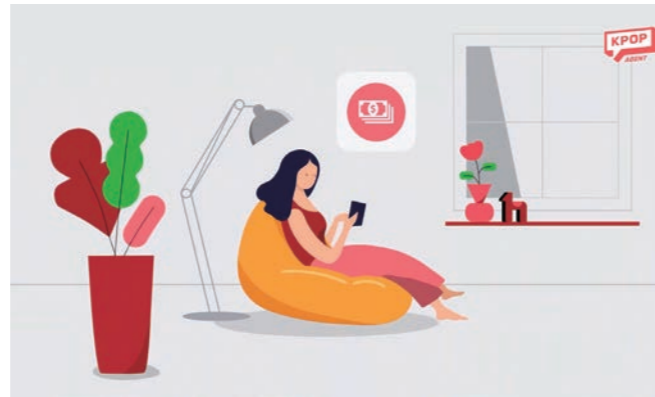
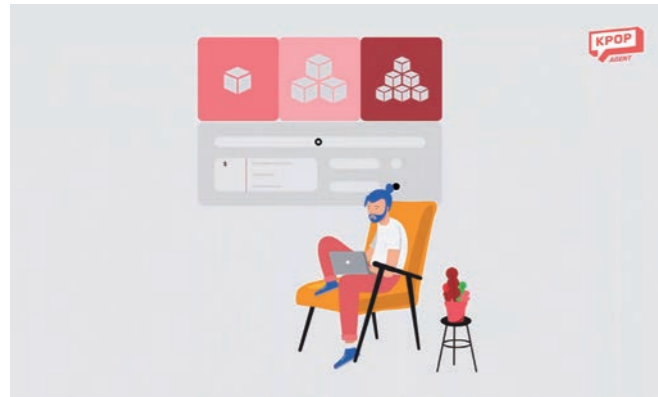
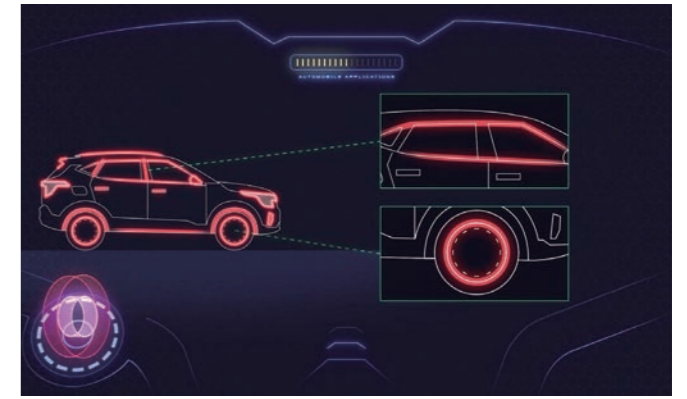
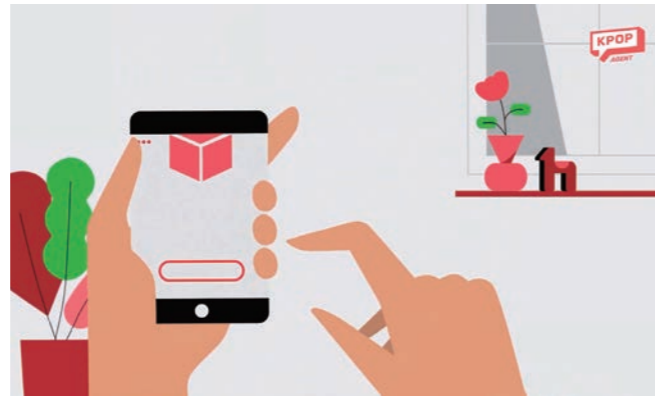

Client: K-POP AGENT
Media Type: 2D Motion Graphics



Client: HANNAM HI-TECH
Media Type: 2D Motion Graphics



WEB DESIGN

- Web Site
- Customized Site
- Detail Page



The Web team works under the strong belief that client's satisfaction comes first. In addition, technical knowledge and new marketing trends are also taken into account when working on various projects. The most functional and aesthetic design created by the Superbee web team enables clients to grow their business and compete in the world market.

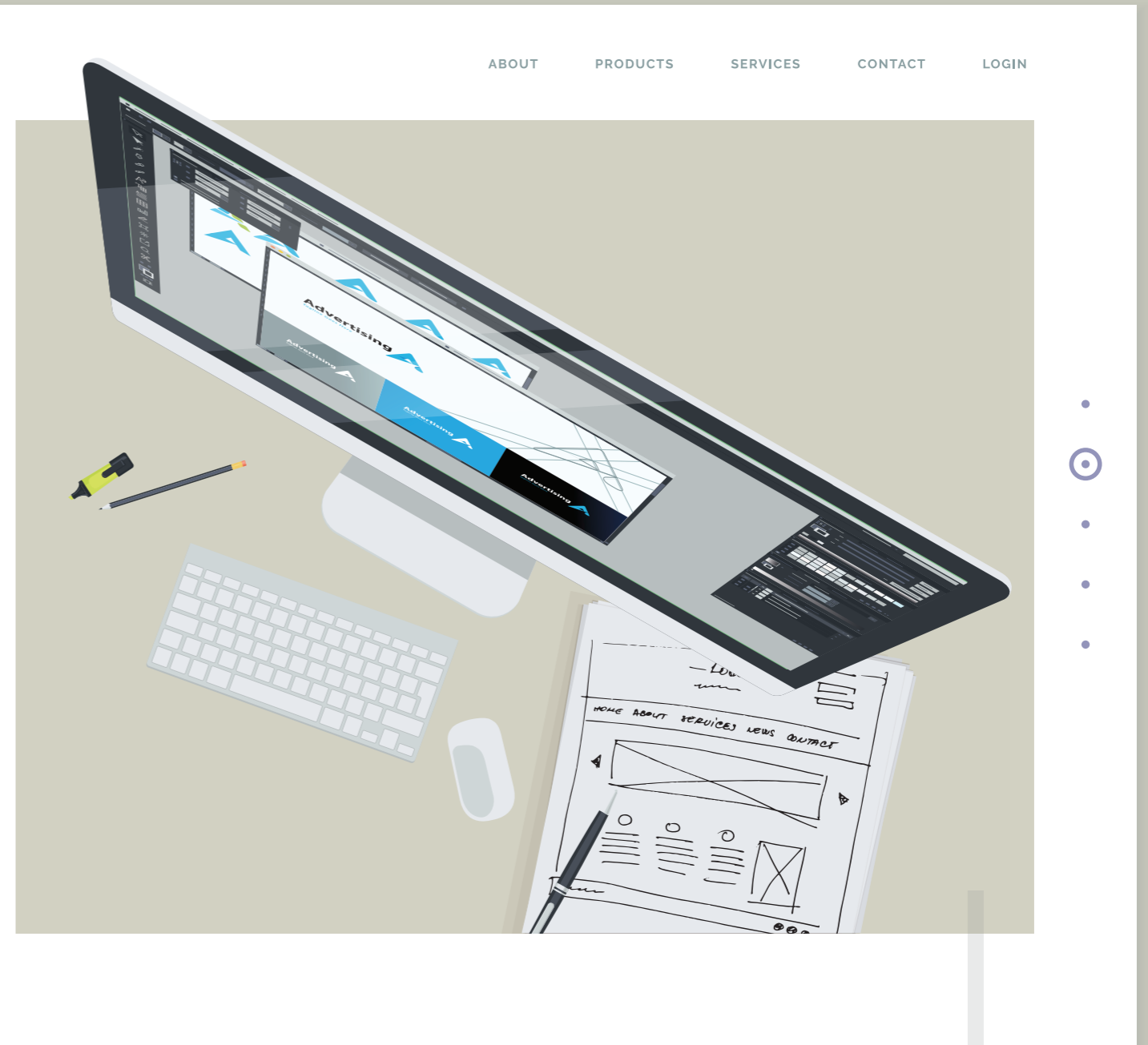



The Web team works under the strong belief that client's satisfaction comes first. In addition, technical knowledge and new marketing trends are also taken into account when working on various projects. The most functional and aesthetic design created by the Superbee web team enables clients to grow their business and compete in the world market.

WEB SITE



Project: Web Site
Category: Chemistry

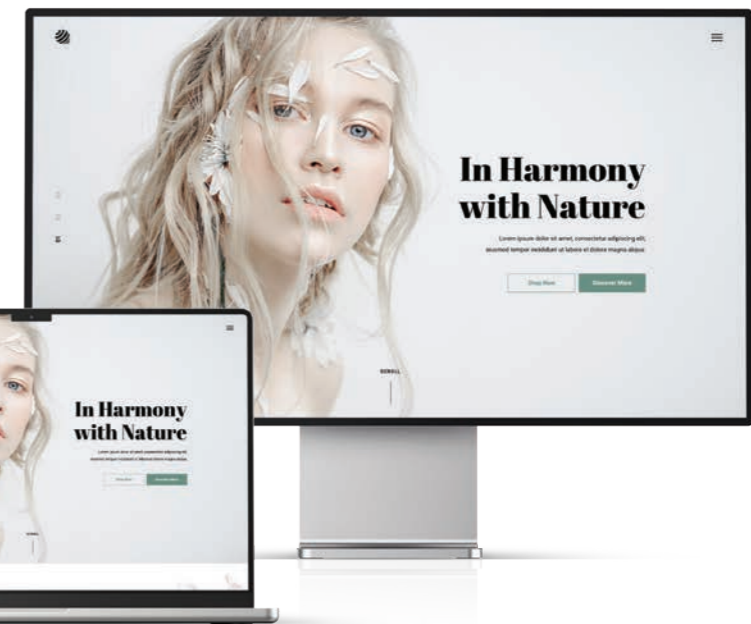

Project: Web Site
Category: Cosmetic



Project: Web Site
Category: Food

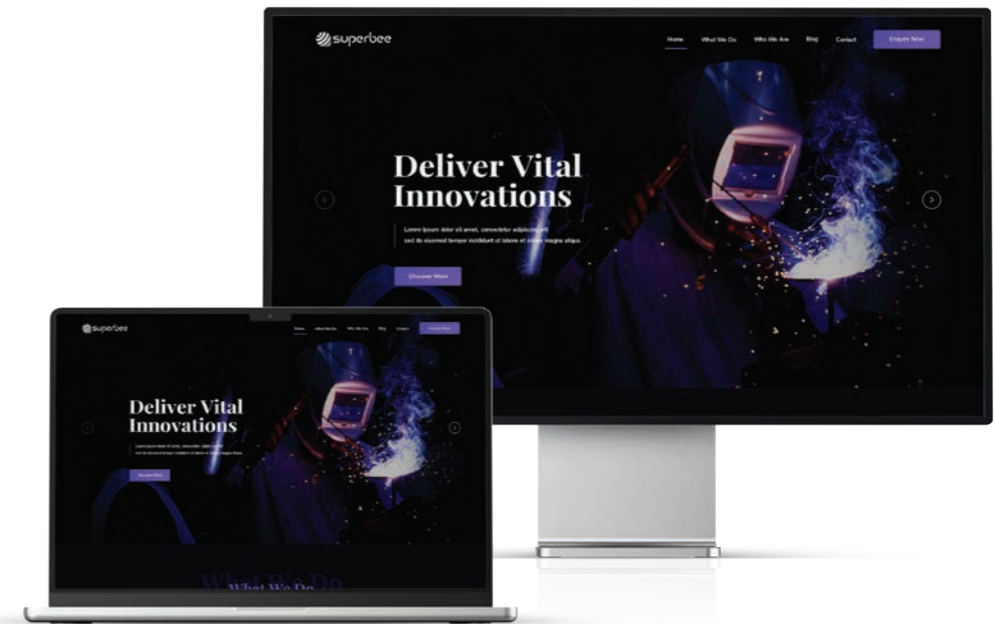

Project: Web Site
Category: Industry

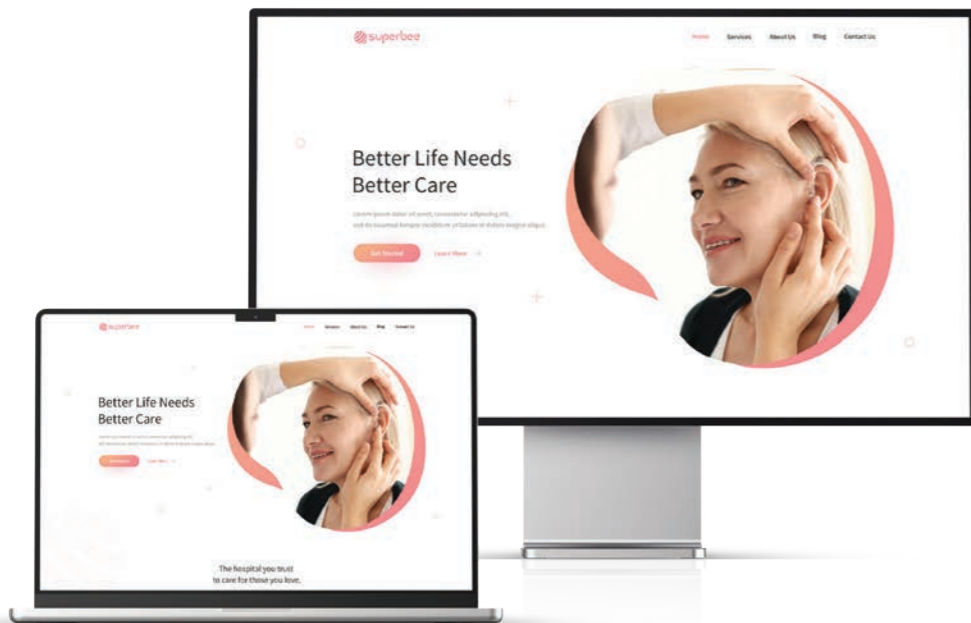

Project: Web Site
Category: Health

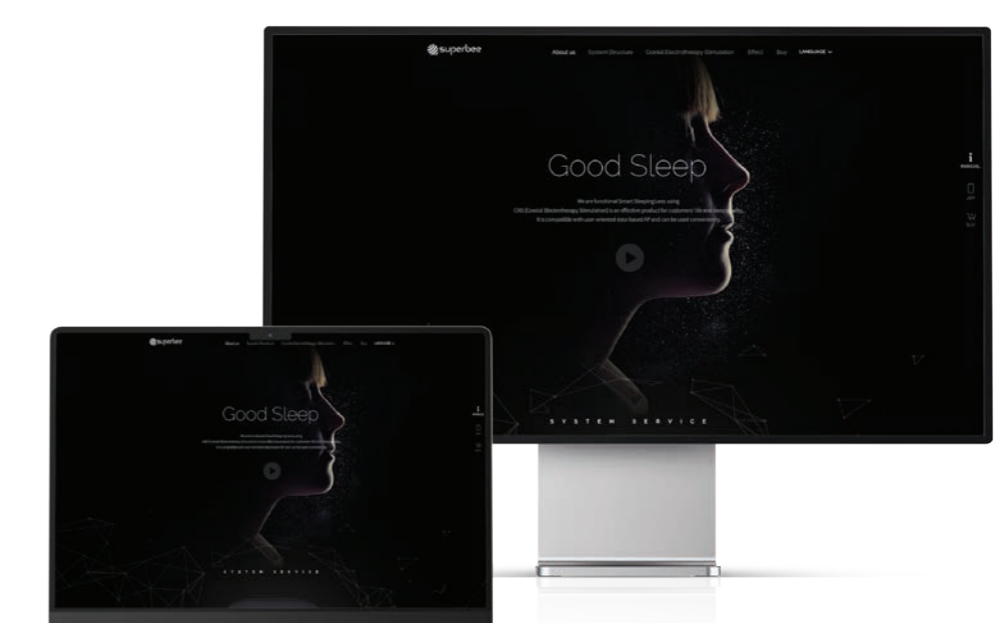

Project: Web Site
Category: Product

CUSTOMIZED SITE

WEB DESIGN

The most functional and aesthetic design created by Superbee.
The web team will contribute to the growth of your business.
We will strive to improve the brand value of our customers in the global market.

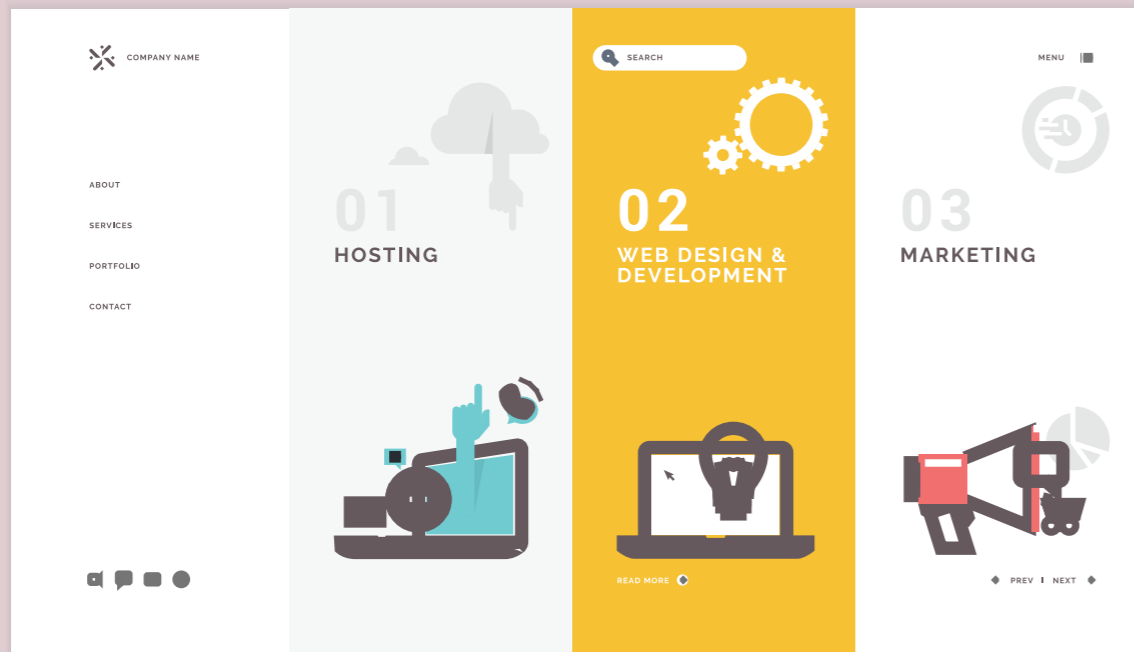

Project: Hwayo
Category: Customized Site

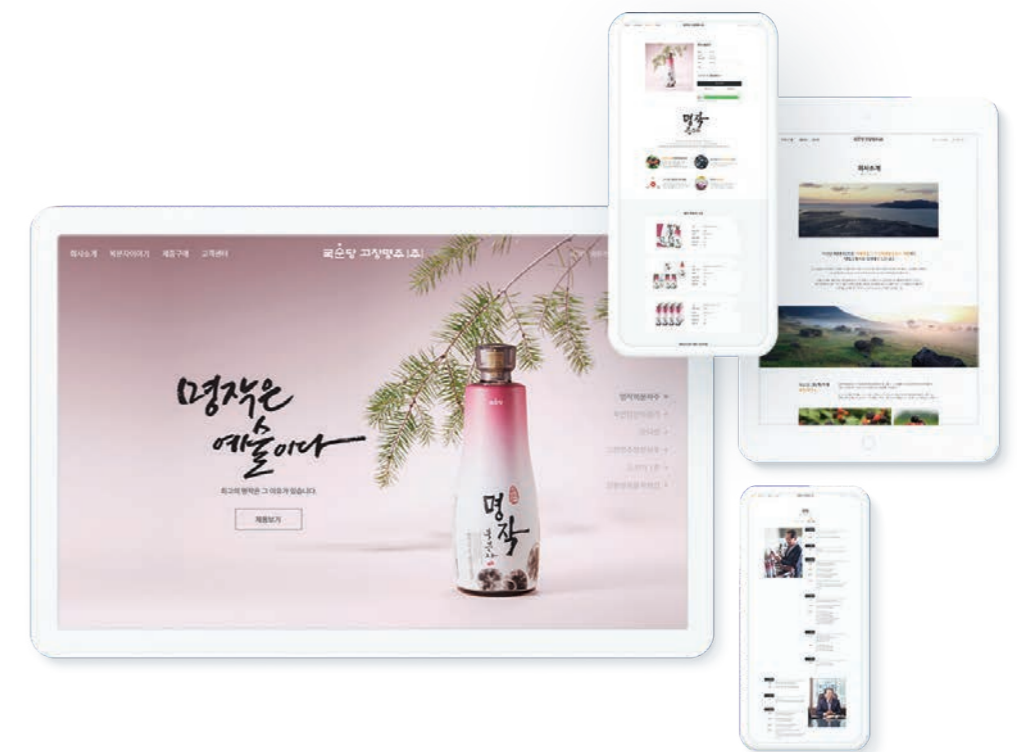

Project: Kooksoondang
Category: Customized Site



Project: Kwangjuyo
Category: Customized Site, Web Catalog



Project: Cheethashow
Category: Customized Site



Elementor Sites of the Month
October 2019

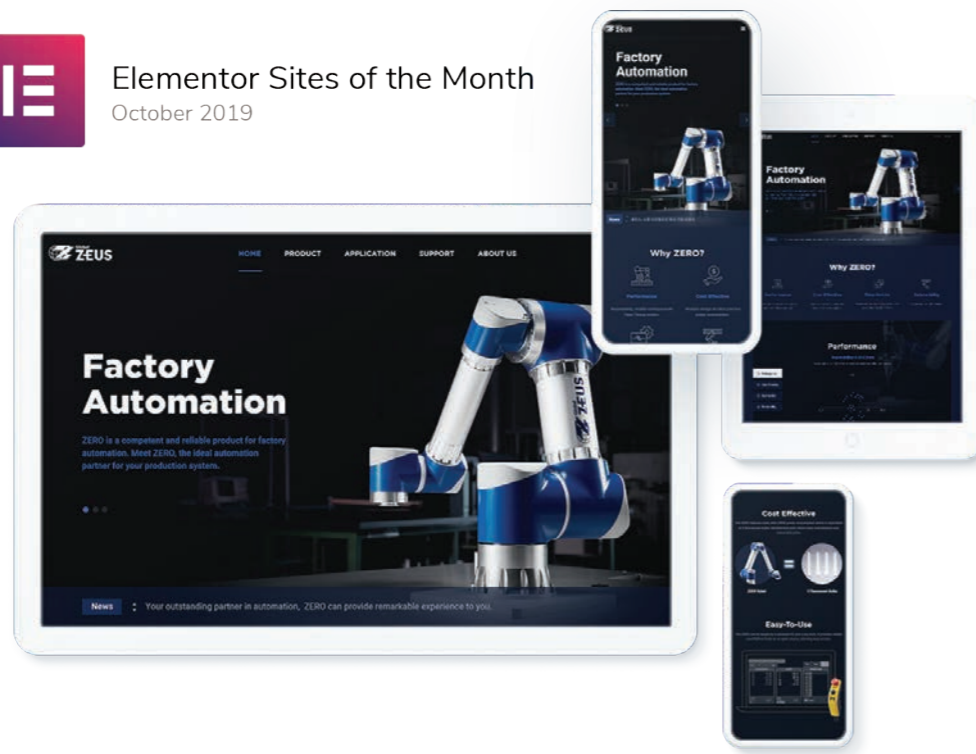

Project: Global Zeus
Category: Customized Site



Project: D.I INTERNATIONAL
Category: Customized Site

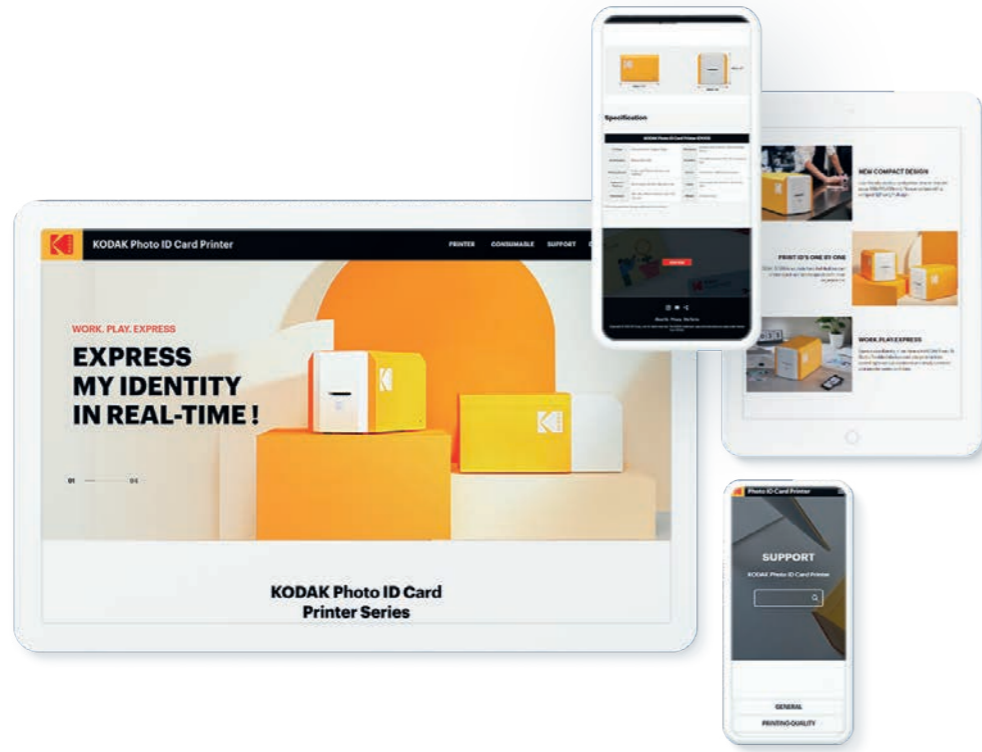

Project: IDP
Category: Customized Site

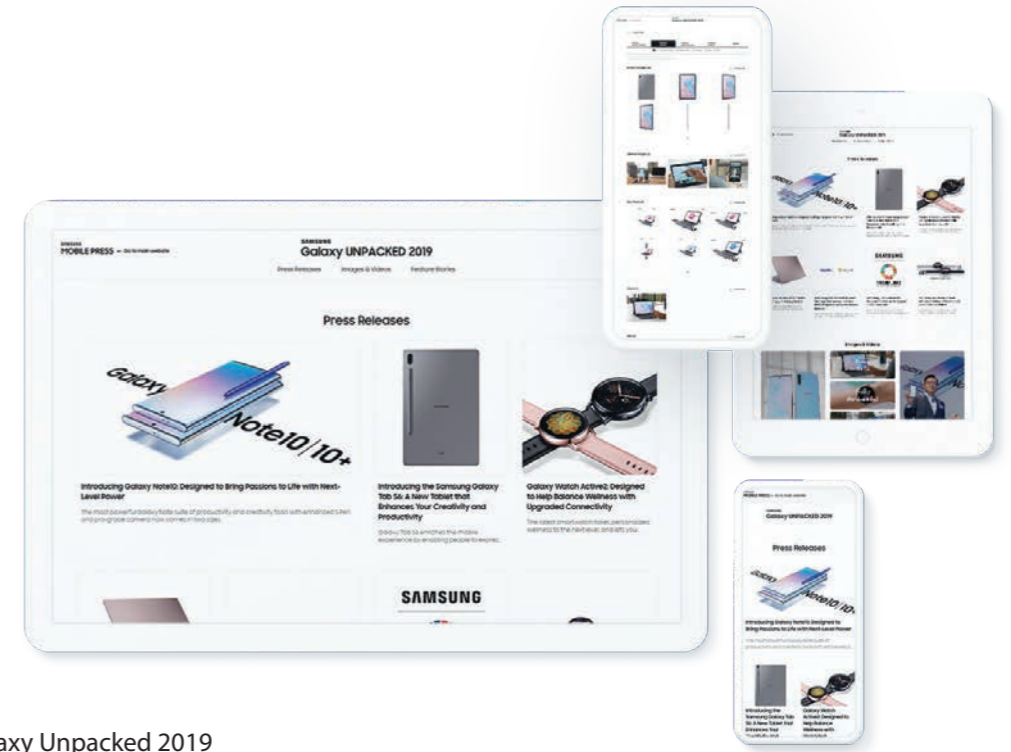

Project: Samsung Galaxy Unpacked 2019
Category: Customized Site

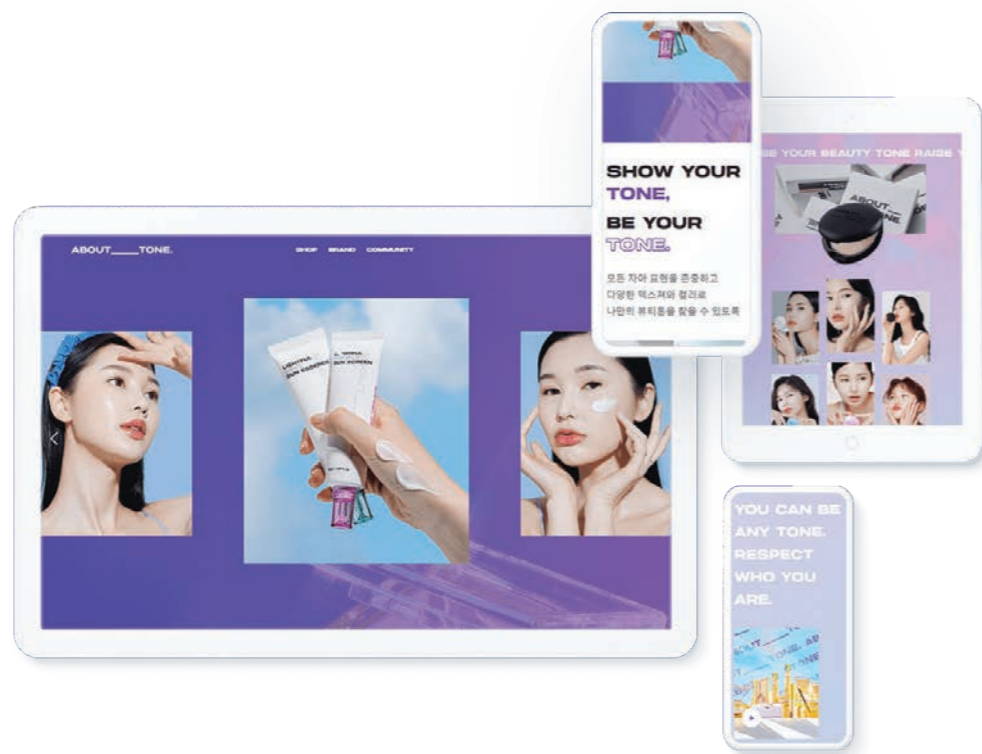

Project: About_tone
Category: Customized Site

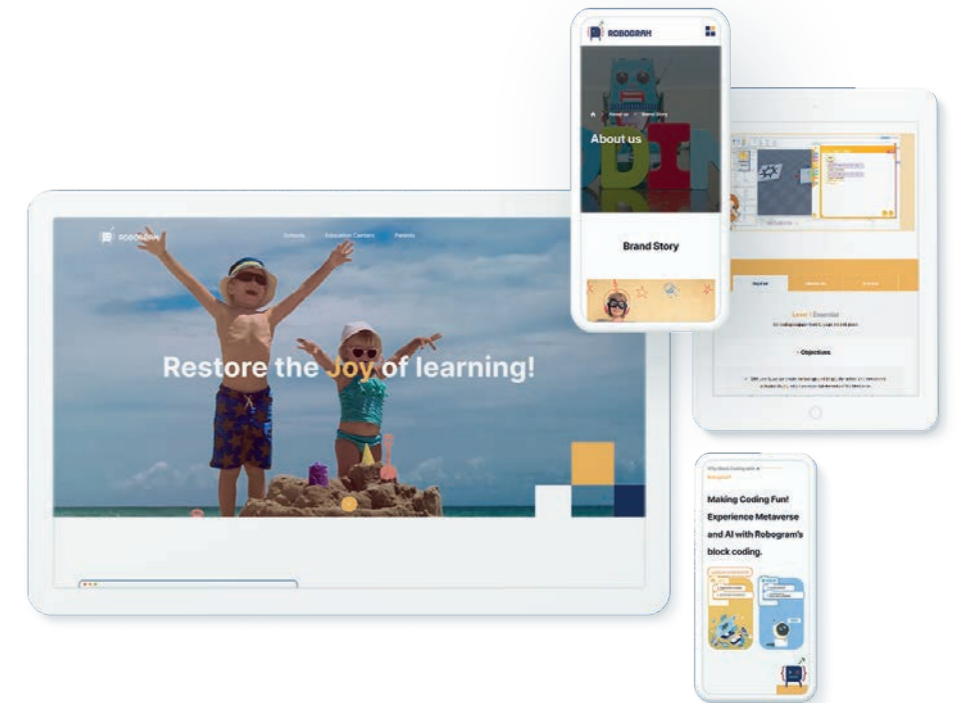

Project: Robogram
Category: Customized Site



Project: PSF
Category: Customized Site



Project: Baekjo Sink
Category: Customized Site

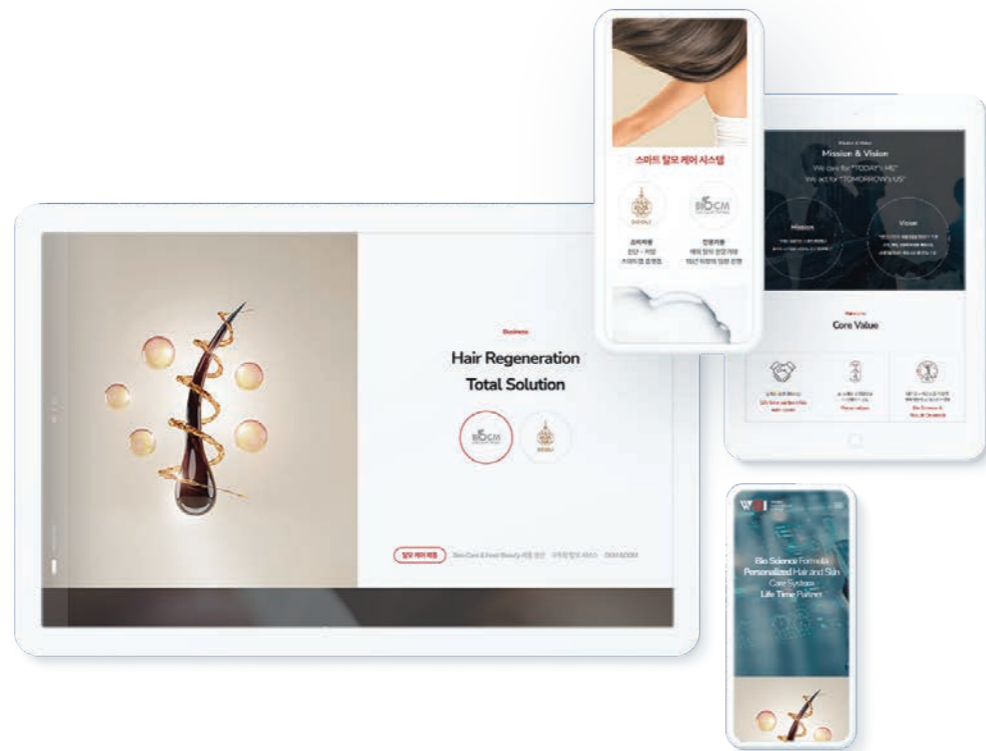

Project: Wellbiz International Limited
Category: Customized Site

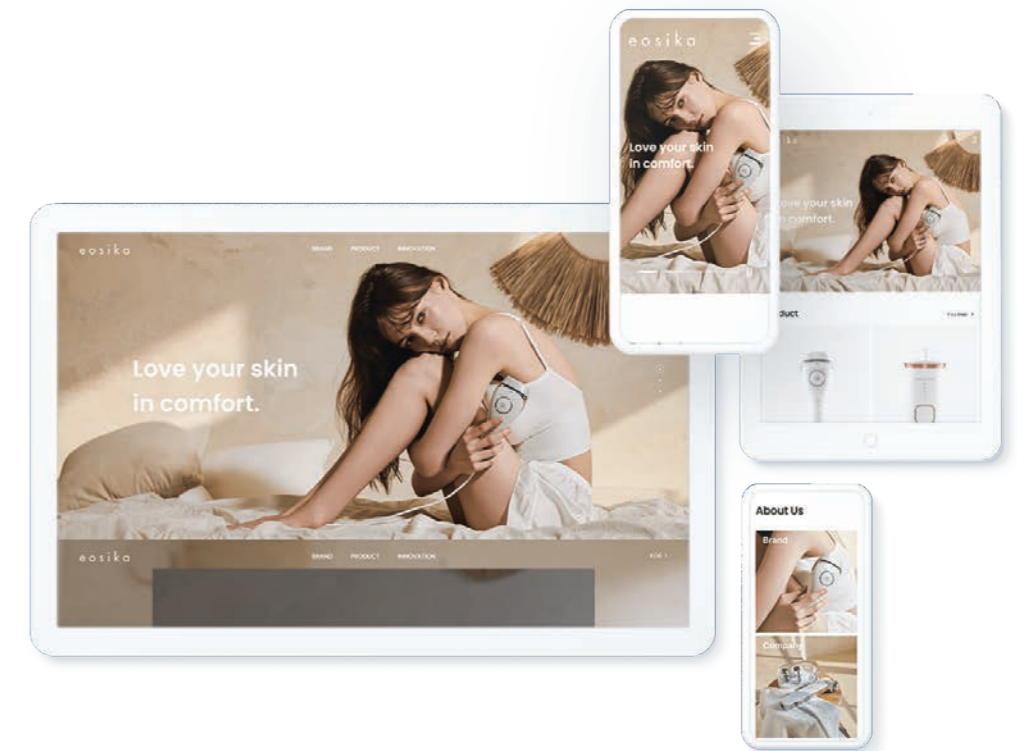

Project: Skinscience
Category: Customized Site

DETAIL PAGE

WEB DESIGN



The most functional and aesthetic design created by Superbee.
The web team will contribute to the growth of your business.
We will strive to improve the brand value of our customers in the global market.

Project: MAYLODEUR
Category: Detail Page



Project: Shoe-Vital
Category: Detail Page





Project: OLHGOK
Category: Detail Page



Project: PROJECT SEL
Category: Detail Page

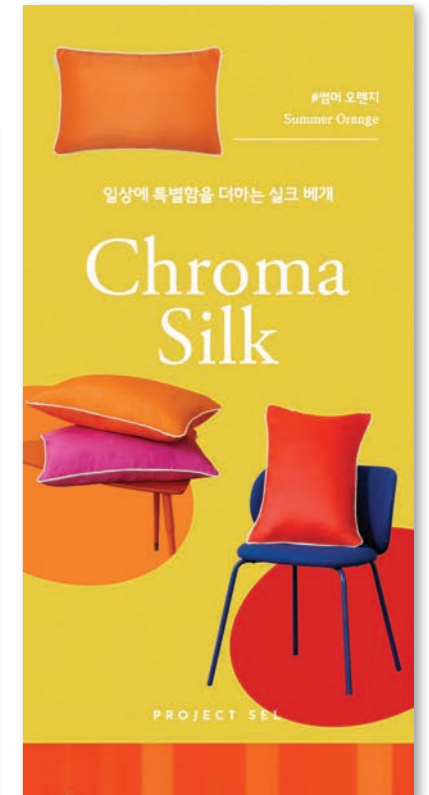

Project: J Micron
Category: Detail Page



Project: Wellbiz MORIMANA
Category: Detail Page



MARKETING

- Viral Marketing
- SNS Marketing
- NAVER Keyword Ads
- Google Ads
- E-commerce
- Live Commerce/
Exhibition Broadcast

The marketing team identifies customers' products or brands with the market environment, trends, and customer needs and provides optimal solutions through various marketing tools such as viral marketing, SNS Marketing, NAVER Keyword Ads, Google Ads, E-commerce and Live Commerce/ Exhibition Broadcast.

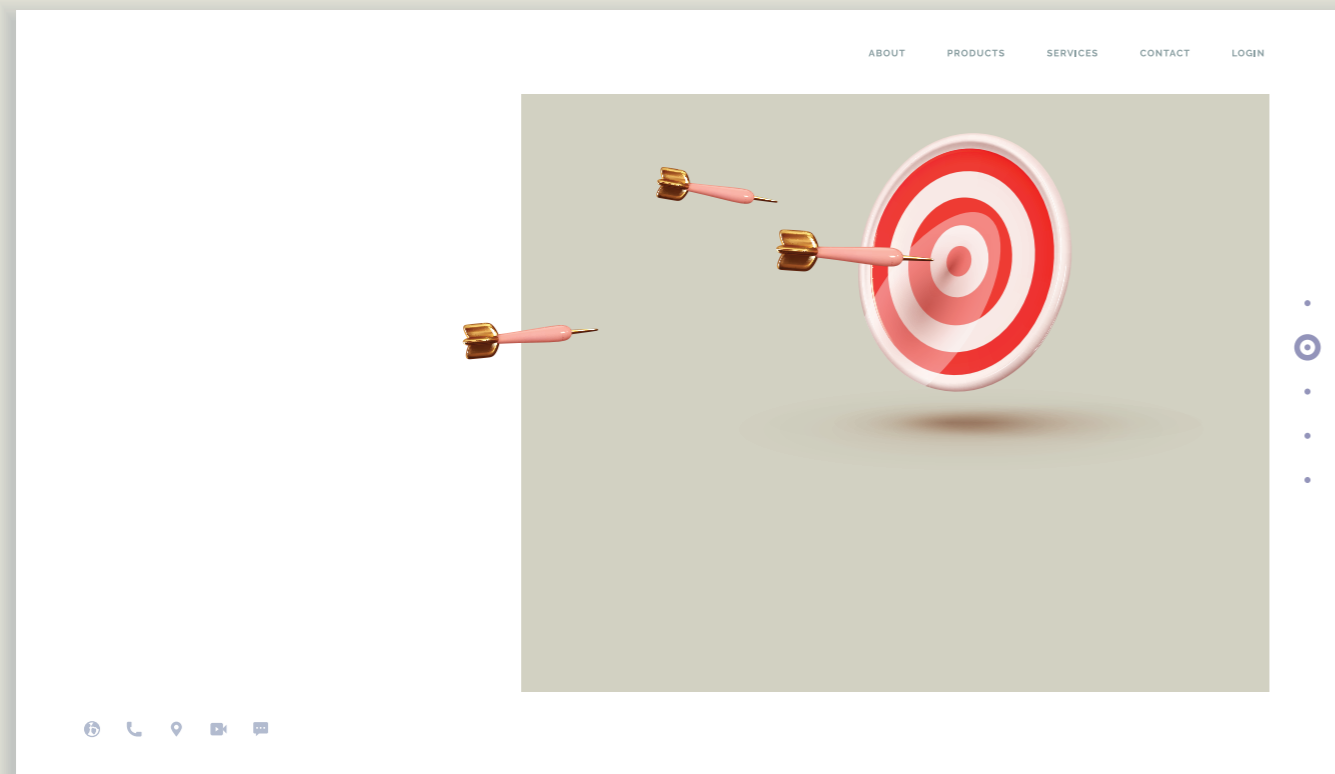

VIRAL MARKETING SNS MARKETING NAVER KEYWORD ADS GOOGLE ADS

MARKETING



Project: Clotoy Viral Marketing
Category: Blog, Youtube, SNS, Cafe





Project: Nanoom Energy
Category: Instagram



Client: SC Commerce
Category: NAVER Keyword Ads

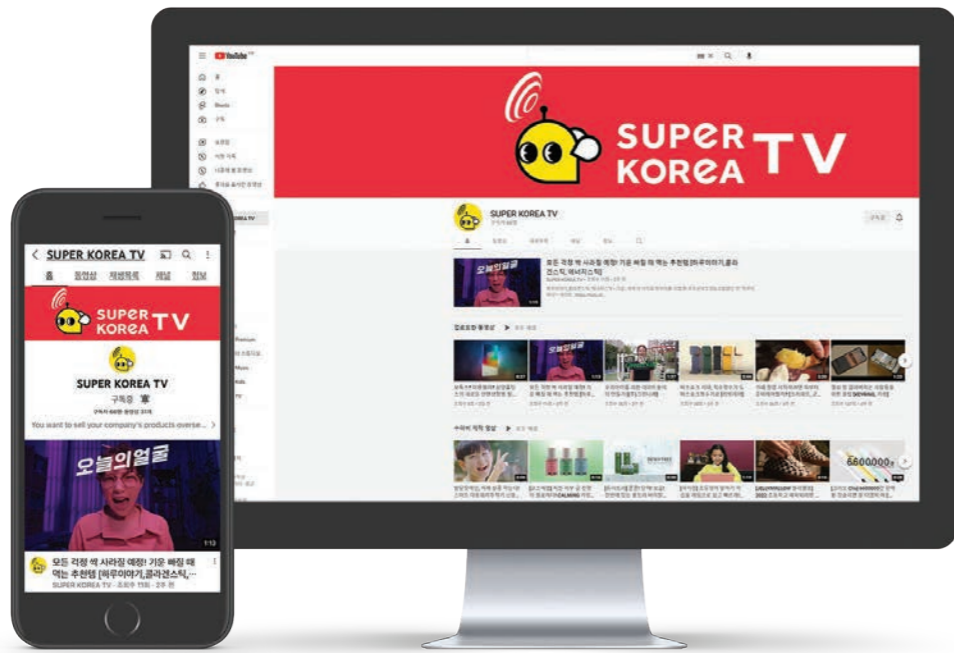

Project: Super Korea TV
Category: Youtube

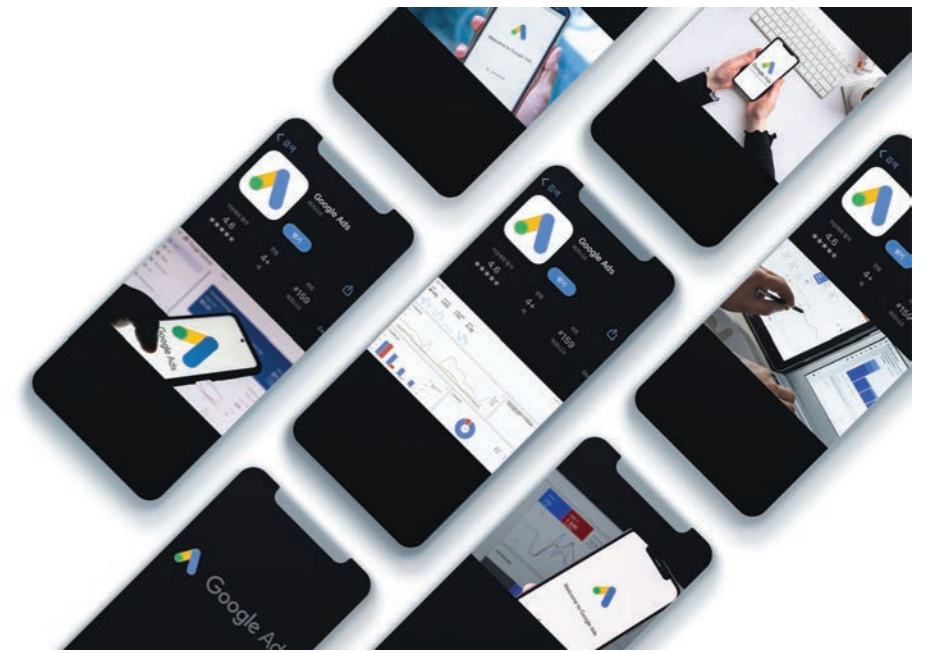

Client: Carima
Category: Google Ads

MARKETING



The marketing team identifies customers' products or brands with the market environment, trends, and customer needs and provides optimal solutions through various marketing tools such as viral marketing, SNS Marketing, NAVER Keyword Ads, Google Ads, E-commerce and Live Commerce/ Exhibition Broadcast.



E-COMMERCE

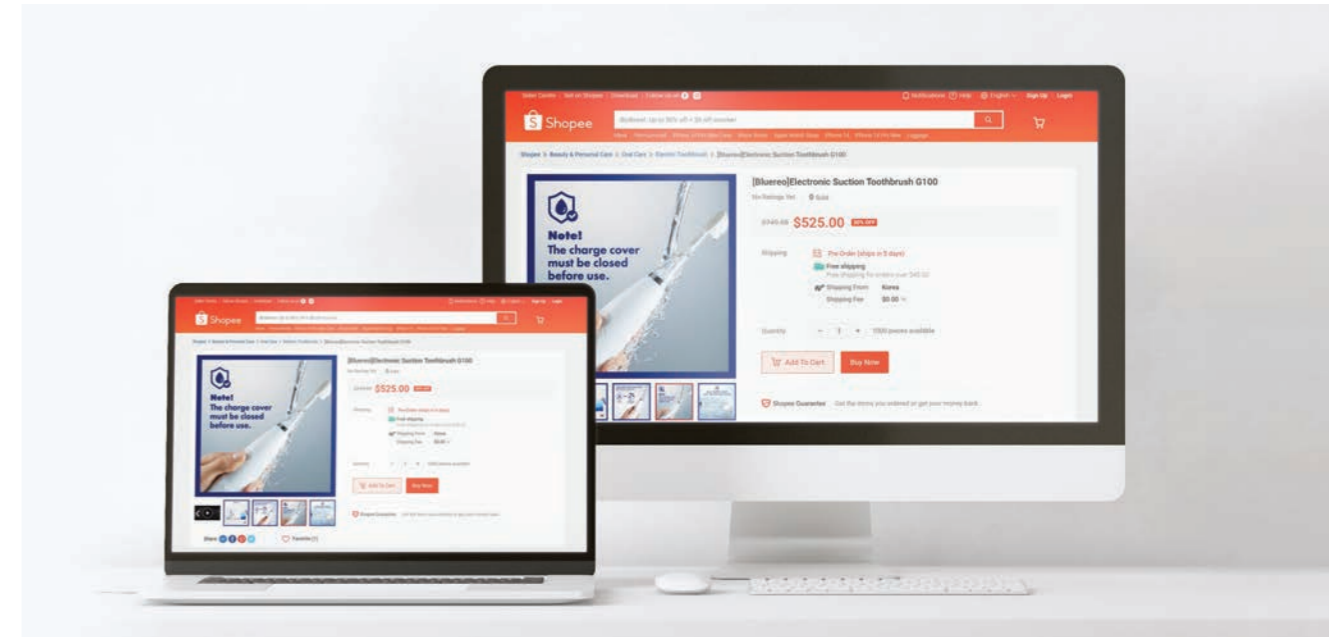

Client: Blureo

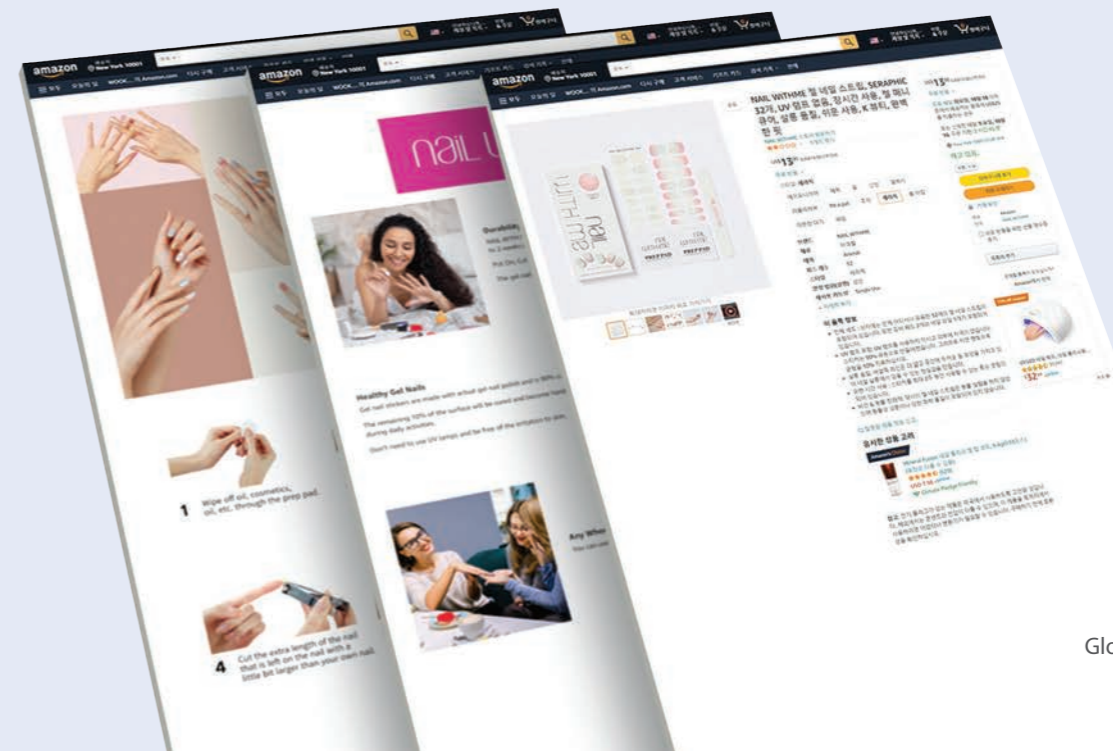

Client: Nail with me

LIVE COMMERCE EXHIBITION BROADCAST

The marketing team identifies customers' products or brands with the market environment, trends, and customer needs and provides optimal solutions through various marketing tools such as viral marketing, SNS Marketing, NAVER Keyword Ads, Google Ads, E-commerce and Live Commerce/ Exhibition Broadcast.

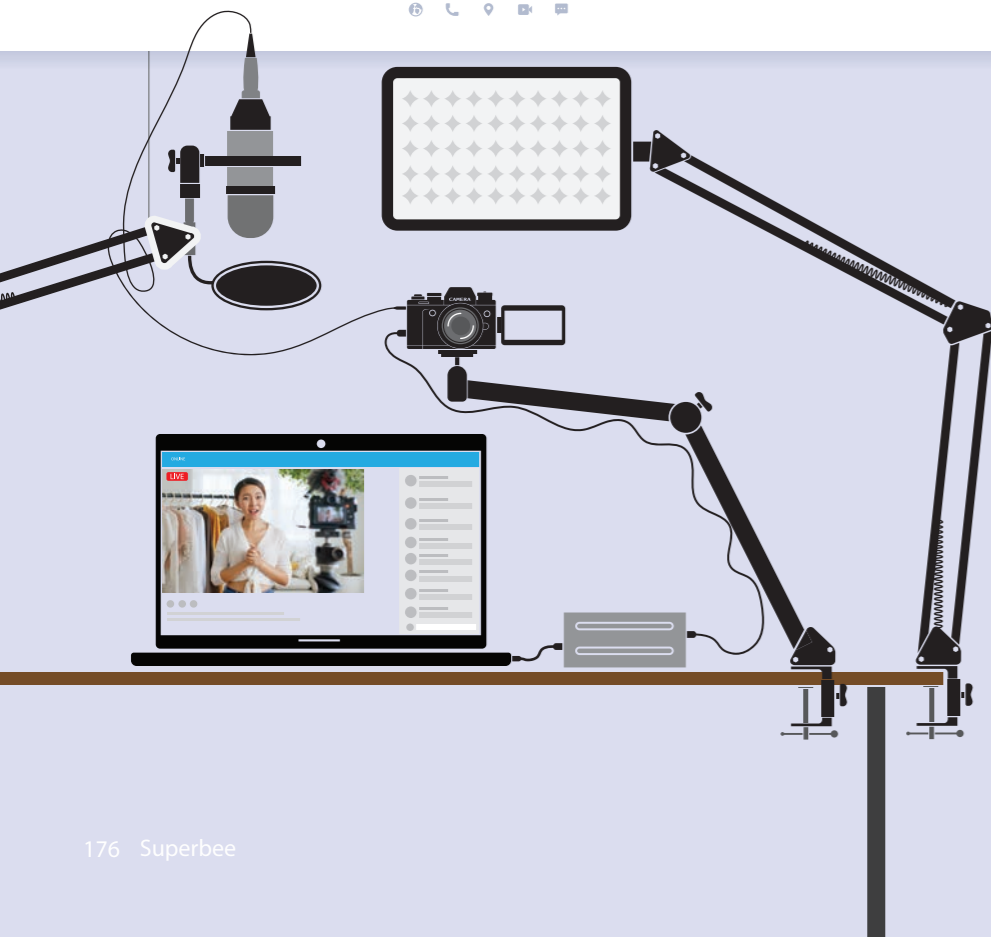
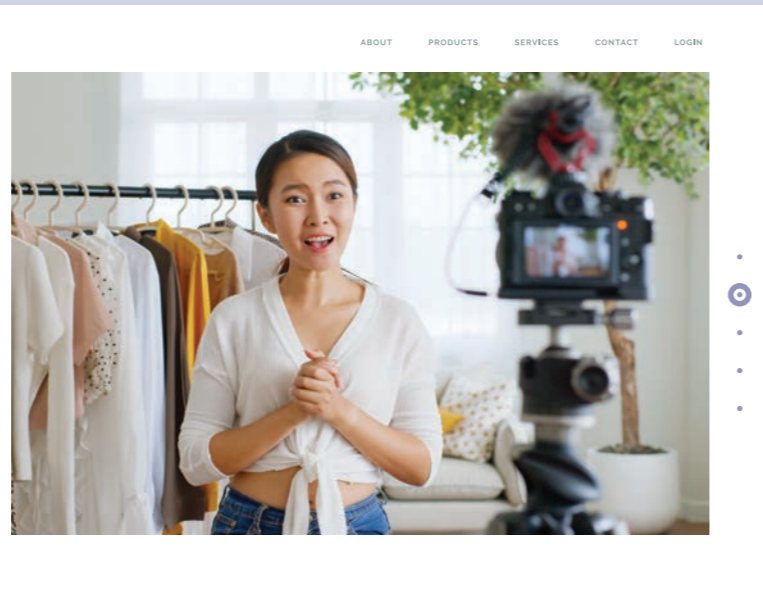

Project: Mixsoon
Category: Live Commerce

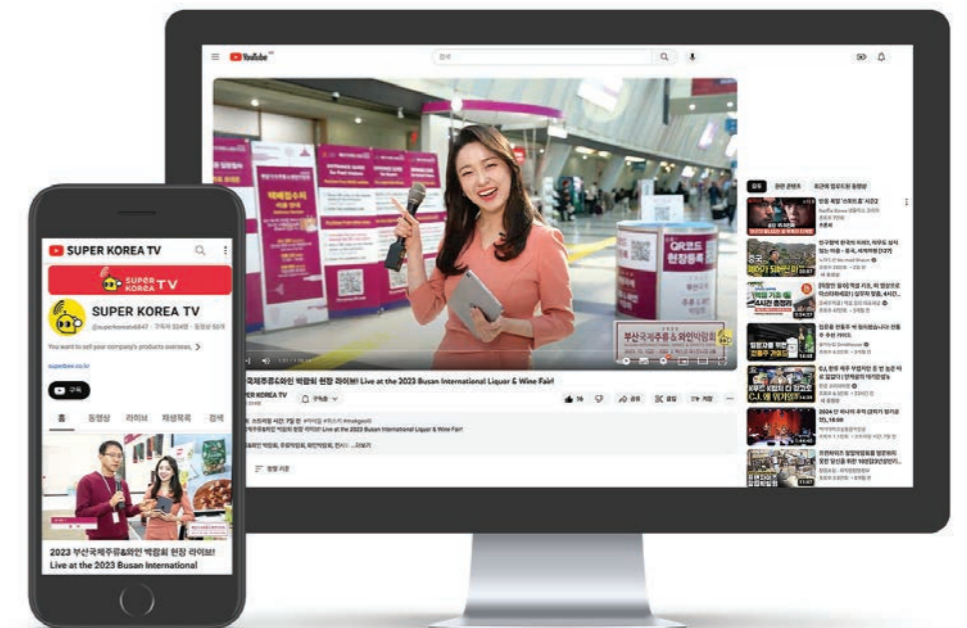

Project: Busan International Liquor Fair
Category: Exhibition Broadcast

**YOU
DREAM,
WE
DESIGN.**

**SUPERBEE
GLOBAL DESIGN
GROUP**





Head Office / Studio

T. +82 2 574 8777 F. +82 6339 8288
A. 서울시 서초구 동산로 23 베델회관 7층(양재동)

www.superbee.co.kr